

GNSS Navigation message analysis and perspectives

International Technical Symposium on Navigation and Timing

Dr Axel GARCIA-PENA - *ENAC*

November 2014

Introduction (1/2)

- The GNSS navigation message is a key element of a GNSS system since it carries essential information to calculate the user PVT (Position Velocity Time)
 - Essential information: Satellites Ephemeris and Satellite Clock Error corrections (CED), message time stamp
- Traditionally, less crucial information such as the satellites almanacs, the ionosphere and the troposphere correction, etc, was also carried by the message but the total amount of data remained small and easily manageable.
- Therefore, the implementation of the communication part of the GPS L1 C/A signal was subordinated to the implementation of the synchronization part

Introduction (2/2)

- The communication part of a signal can be divided into two main functions:
 - 1) Transmission of the information: How the information is transmitted and which C/N_0 is required to access this information
 - Fields: Digital Modulation, Channel Coding
 - 2) Information Integrity: How the transmitted information integrity is guaranteed
 - Fields: Channel Coding, Authentication (not presented)
- Nowadays, the continuous growth of GNSS applications results in the considerable increase of the information to be broadcast such as Precise Positioning, Safety of Life (SoL)
- Moreover, due to the expansion of the GNSS mass market applications in suburban, urban and indoor environments, the GNSS signal has to be adapted to suburban, urban and indoor environments
- Therefore, the GNSS navigation signal and message must continue to evolve in order to meet the ever evolving user needs.

Outline

1. Navigation Message Evolution
2. New demodulation performance methodology in mobile channels
3. Code Shift Keying (CSK) modulation
4. GNSS Signal with variable data rate

Outline

1. **Navigation Message Evolution**
 - a) **Navigation message GPS L1 C/A**
 - b) **Navigation message GPS L2C, L5 and SBAS L1**
 - c) **Navigation message GALILEO E1 OS**
 - d) **Navigation message GPS L1C**
 - e) **GNSS signal comparison in an AWGN channel**
2. New demodulation performance methodology in mobile channels
3. Code Shift Keying (CSK) modulation
4. GNSS Signal with variable data rate

1. Navigation Message Evolution

- A good perspective of the navigation message evolution is necessary to design a new signal/message. The following characteristics of the message are discussed:
 - 1) Message structure
 - 2) Forward Error Correction:
 - Channel code is implemented to allow the message correction at reception.
 - Demodulation performance depends on the modulation and FEC channel code
 - 3) Message content Integrity:
 - How the data integrity is checked and its limitations
 - 4) Message content:
 - Whether the message is repeated from one frame/subframe to next one → Allow the coherent message accumulation → C/N_0 increase
- Only meaningful evolutions will be commented for each message

1a. Navigation message GPS L1 C/A (1/2)

Message Structure (sent to the channel):

- Continuous stream of frames: a frame of 1500 bits is constituted of 5 subframes
- Each subframe of 300 bits is constituted of 10 codewords
- Each codewords is constituted of 30 bits: 24 information bits and 6 parity bits
- Rigid structure: Contents of each subframe follow a cyclic schedule

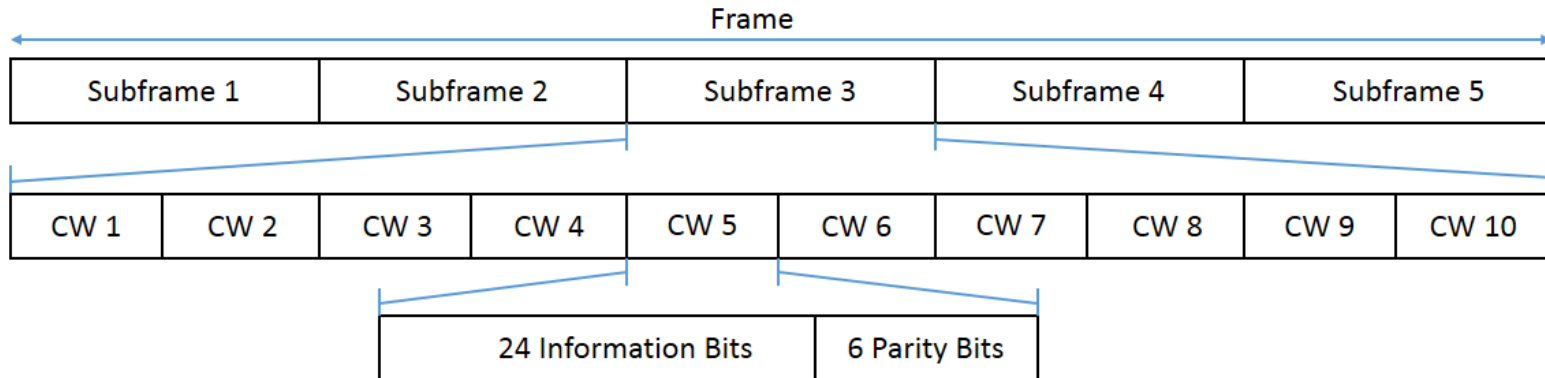

Forward Error Correction (FEC):

- No channel code is implemented to apply the FEC
- The GPS L1 C/A signal demodulation performance depends only on the demodulation performance of the BPSK modulation

1. Navigation message GPS L1 C/A (2/2)

Integrity:

- GPS L1 C/A message integrity is controlled by an Extended Hamming code (32,26)
- Theoretically, this code can detect up to 3 errors with a 100% probability in a codeword.
- Theoretically, the probability of not being able to detect a pattern of errors in a codeword is:

$$P_{nd} = \frac{\text{num codewords}}{\text{num combinations received bits}} = \frac{2^{26}}{2^{32}} = 2^{-6} = 0.0156$$

1b. Navigation message GPS L2C, L5 and SBAS L1 (1/2)

Information Message Structure: GPS L2C and GPS L5

- Continuous stream of information messages.
- Each message is constituted of 300 bits: 276 information bits and 24 CRC bits
- First information bits are: 8b preamble, 6b SV Id, 6b Message Id
- Flexible structure: Message contents (or Id) are determined by time outs

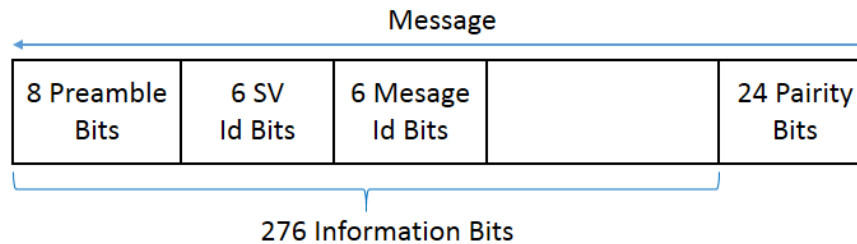

Information Message prior to BPSK modulator:

- The continuous stream of information messages are fed to an encoder block
- The output of the encoder block is sent (after BPSK modulation) to the channel

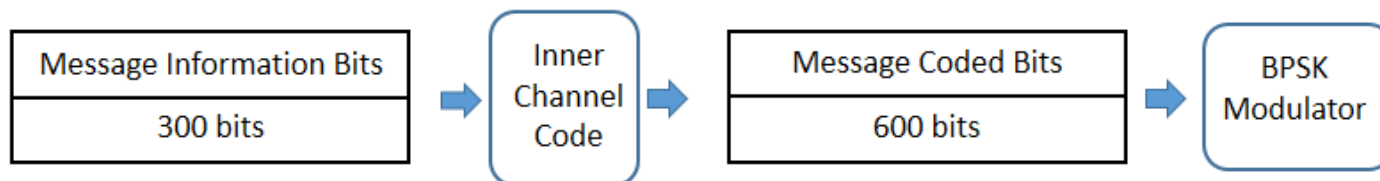

1b. Navigation message GPS L2C, L5 and SBAS L1 (2/2)

Forward Error Correction (FEC):

- Referred as Inner channel code, it is a convolutional channel code, CC(171,133) with $r = 1/2$, $L = 7$
- Therefore, each information word is converted into 600 coded bits.
- The introduction of a CC makes the navigation message more robust to the noise:

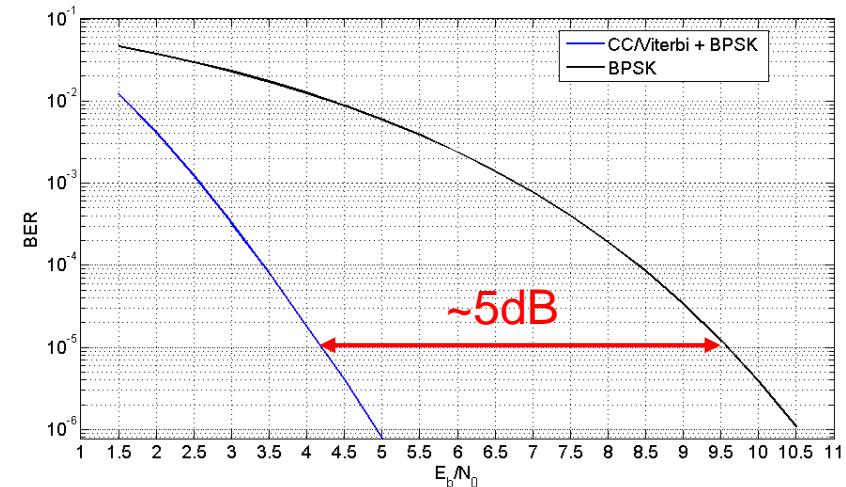

➔ For a BER= 10^{-5} , about 5dB less will be required

Integrity:

- GPS L2C message integrity is controlled by a Cyclic Redundancy Code, CRC-24Q
- CRC-24Q performance:
 - It detects all single bit error, double bit error, any odd number of errors and any burst error with length $b \leq 24$ bits per code word (300 information bits)
 - The fraction of error bursts of length $b > 24$ that are undetected is:
 - $P_{nd} = 2^{-23} = 1.19 \times 10^{-7}$, if $b = 25$ bits
 - $P_{nd} = 2^{-24} = 5.96 \times 10^{-8}$, if $b > 25$ bits

1c. Navigation message GALILEO E1 OS (1/2)

Information Message Structure:

- Continuous stream of frames, where each frame is constituted of 24 subframes
- Each subframe is constituted of 15 pages (or words)
- Each page (or word) is constituted of two page parts
- Each page part is constituted of 120 bits

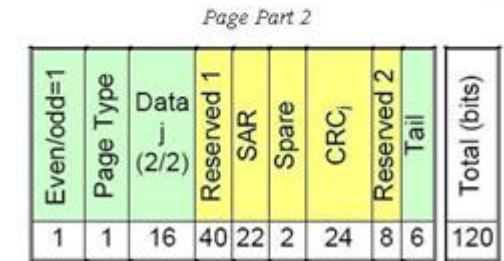
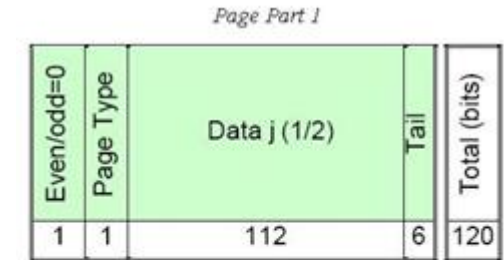

Information Message prior to CBOC modulator:

- GPS L2C/L5 scheme is applicable to GALILEO E1 OS, but with some modifications.
- Before, sending the page parts to the channel (after CBOC modulation), the page parts are encoded, interleaved and a preamble of 10 bits is inserted at the beginning.

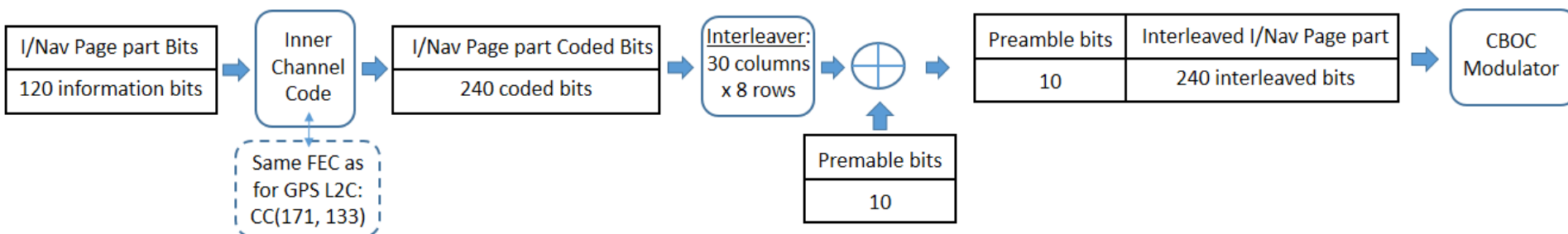

1c. Navigation message GALILEO E1 OS (2/2)

Forward Error Correction (FEC):

- The same channel code as GPS L2C is used to implement the FEC: CC(171,133)
- Difference: 6 tail bits are inserted at the end of each page part
 - Advantage: Allows the implementation of an interleaver
 - Drawback: Preamble bits are no longer protected by the FEC (w.r.t. GPS L2C)

Interleaver:

- Rectangular interleaver with dimensions, (30 columns x 8 rows), applied to 1 page
- Function: To make the navigation message more robust to its transmission through a mobile channel by breaking the burst of errors introduced by the channel

1d. Navigation message GPS L1C (1/2)

Information Message Structure:

- Continuous stream of frames, where each frame is constituted of 3 subframes
- Subframe 1 contains the Time of Interval (TOI) and is constituted of 9 information bits
- Subframe 2 contains the CED and is constituted of 600 bits (576 info bits and 24 CRC bits)
- Subframe 3 contains variable data and is constituted of 274 bits (250 info bits and 24 CRC bits)

Information Message prior to TMBOC modulator:

- For the first time, subframes have different sizes and are encoded with different channel codes
- Subframes 2 and 3 are interleaved together

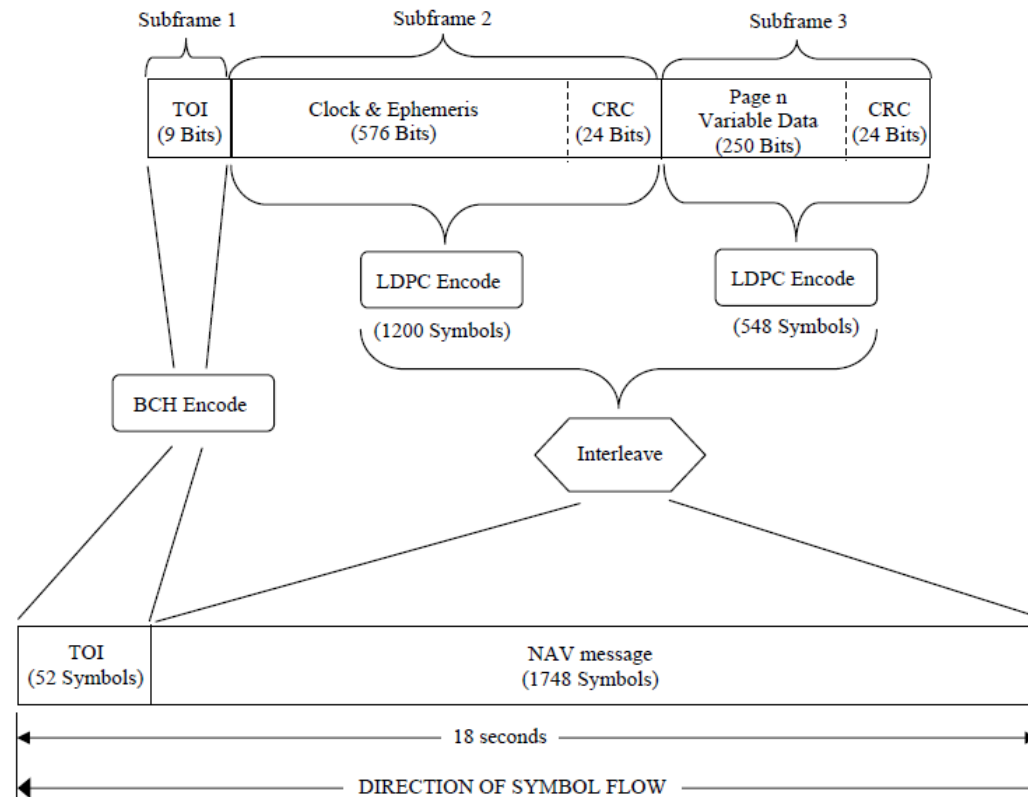

1d. Navigation message GPS L1C (2/2)

Forward Error Correction (FEC):

- Subframe 1 is encoded with an extended BCH(52,9) with minimum distance, $d_{min}=20$
- Subframe 2 is encoded with a LDPC(1200,600) and subframe 3 with a LDPC(548,274)
- LDPC are very powerful codes which obtain near shanon limit performance
- Both LDPC codes and BCH(52,9) obtain better demodulation performance than the CC(171,133)

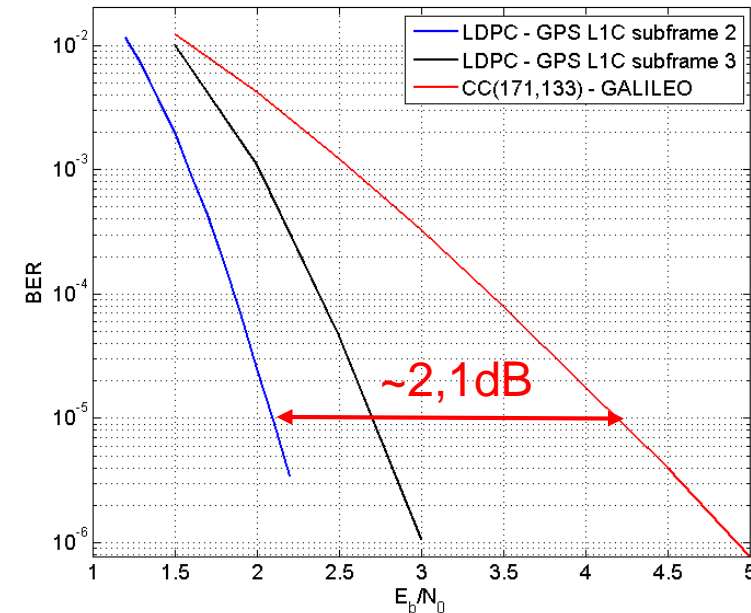

Message Content Repetition

- Subframe 2 replicas can be coherently accumulated for 2h and thus the received C/N_0 is increased with each coherent accumulation:

$$\text{Gain } C/N_0 = 10 \log_{10}(\text{number of accumulated subframes})$$

1e. GNSS signal comparison in an AWGN channel

- The demodulation performance of signal in an AWGN as a function of the received C/N_0 depends on three main factors:
 - Signal modulation → BPSK for all GNSS/SBAS signals (from demodulation performance point of view)
 - Implemented channel code to apply the FEC
 - Symbol rate
- The Clock Error Corrections and Ephemeris Error Rate (CEDER) as a function of the received C/N_0 in an AWGN is presented for the main GNSS signals

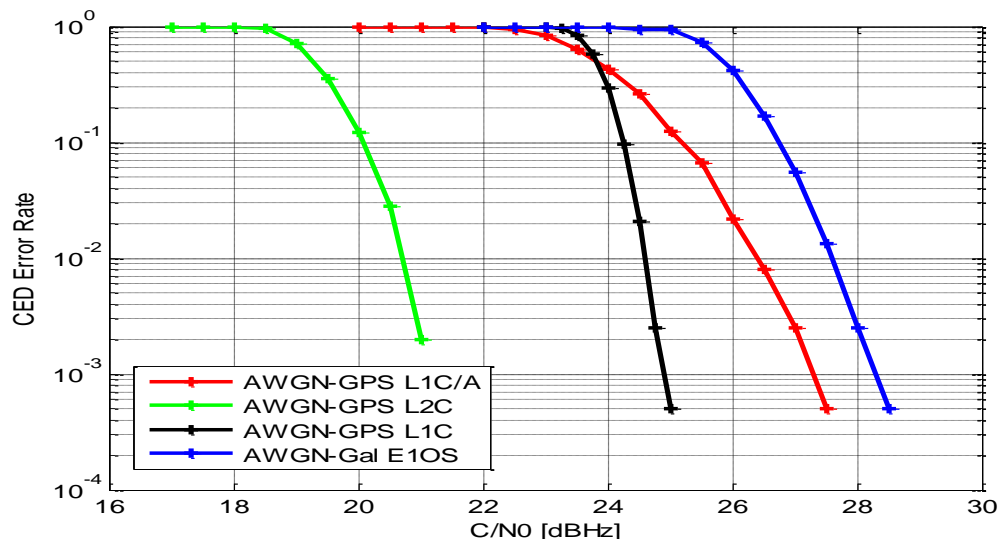

Outline

1. Navigation Message Evolution
- 2. New demodulation performance methodology in mobile channels**
3. Code Shift Keying (CSK) modulation
4. GNSS Signal with variable data rate

6. New demodulation Performance methodology (1/4)

➤ Developed in M. ROUDIER Ph.D. thesis at ENAC.

Classical Methodology: Data set Error Rate as a function of the received C/N_0

• This methodology presents 2 main limitations for urban environments

➤ Limitation n°1: Received C/N_0 is not constant for signals received in urban environments

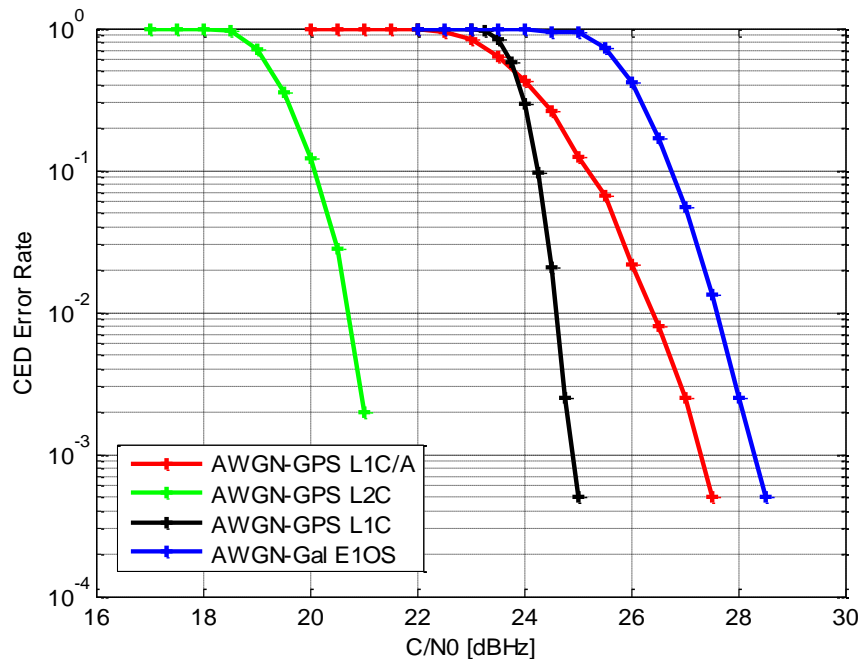

GNSS signals demodulation performance in the AWGN channel with ideal code delay and carrier phase tracking

• Objective:

- Find a C/N_0 which is constant a long time for any urban user
- Find a C/N_0 which is representative from an operational point of view.

• Proposition:

- $C_{pre-urban}/N_0$:

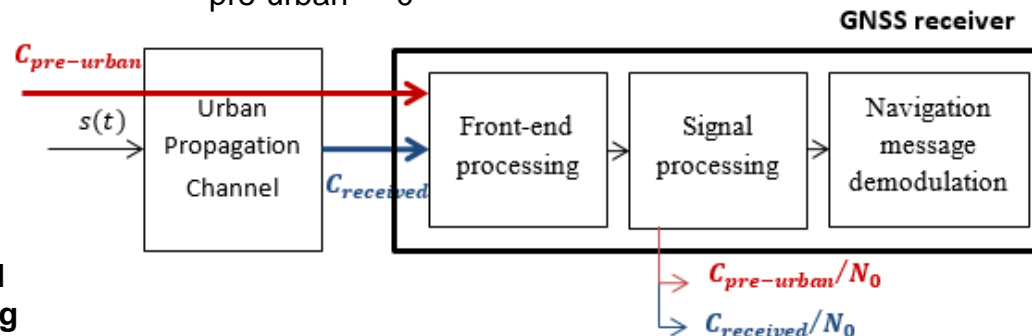

6. New demodulation Performance methodology (2/4)

- Operational point of view: a user moving inside an urban environment observes a constant $C_{\text{pre-urban}}/N_0$ from a satellite with a fixed elevation
- Future step: Knowing the receiver architecture and interference environment, the demodulation performance can be given as a function of the satellite elevation
- Limitation n°2: For a GNSS signal, only punctual instead of continuous message demodulations are required

- Objective: Combine the next characteristics:

- GNSS requires punctual demodulation
- Urban environments have dynamic signal reception conditions

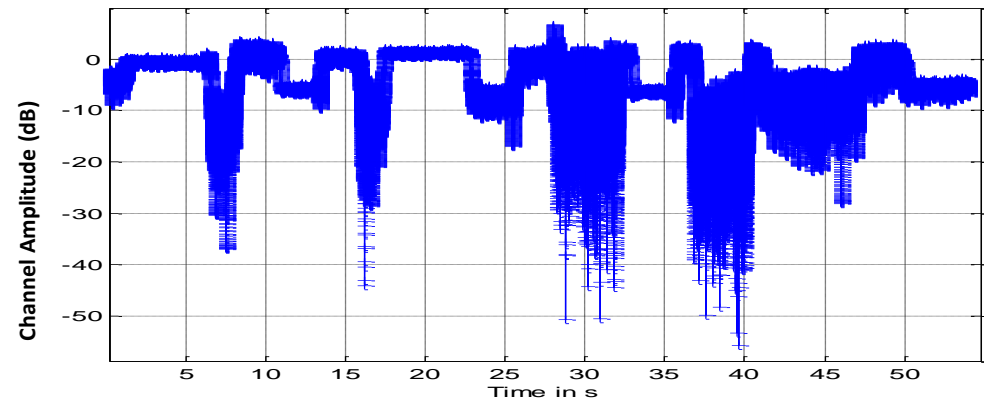
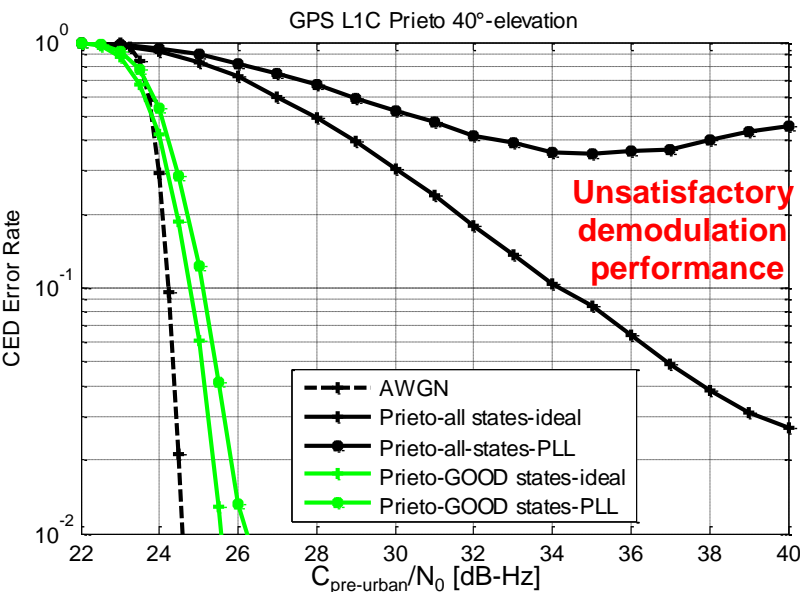

Channel amplitude with the Prieto channel model

GPS L1C CED demodulation performance with the Prieto model

6. New demodulation Performance methodology (3/4)

- Proposition:

- 1) Separating the reception message conditions into favorable reception conditions and unfavorable reception conditions
- 2) Providing demodulation performance for favorable reception conditions
- 3) Providing the occurrence rate: Statistical information about the occurrence of the message favorable reception conditions.

- **Occurrence rate:**

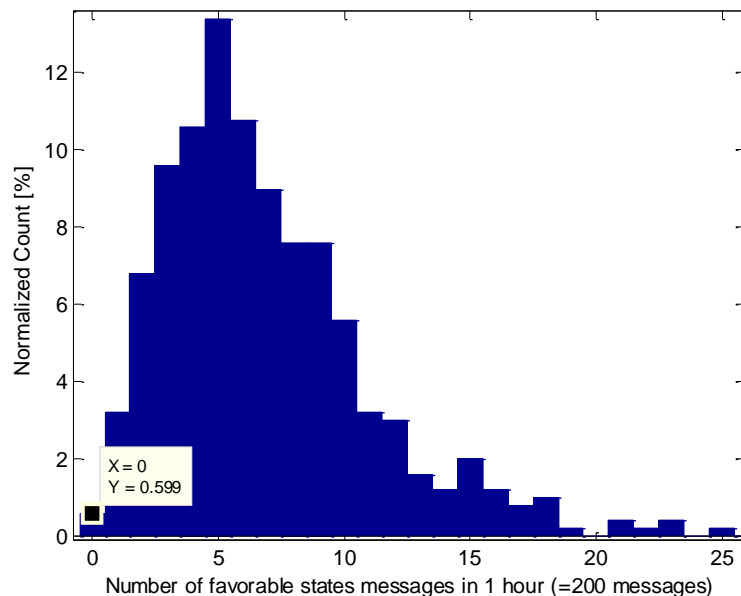

➤ Key point: To define a criterion which provides the 'favorable state messages' having the best possible demodulation performance (work to do).

Favorable state occurrence rate, $T_{occ} = 1h$, for GPS L1C frame using the Prieto channel model with 40° of elevation considering the Prieto channel GOOD states as favorable reception conditions

6. New demodulation Performance methodology (4/4)

- Methodology until now: Providing:
 - a) Data set Error Rate vs $C_{\text{pre-urban}}/N_0$ only for given favorable reception conditions
 - b) Statistical occurrence values of these favorable reception conditions
- Remaining question: Which statistical occurrence values are considered acceptable?
 - Determined by the operational requirements

Link between the statistical occurrence/Error Rate and operational requirements

- Low level requirements are defined to achieve this link: reception of a given data set by 1 single satellite during a continuous period of time.

Example

To determine if a GPS L1C receiver can calculate a continuous valid position during 4 consecutive hours, with a probability greater than 95%

Outline

1. Navigation Message Evolution
2. New demodulation performance methodology in mobile channels
3. **Code Shift Keying (CSK) modulation**
4. GNSS Signal with variable data rate

7. Code Shift Keying (CSK) modulation (1/6)

CSK Definition: CSK is an orthogonal M-ary modulation since M orthogonal signaling waveforms are used in order to transmit $U = \log_2(M)$ bits.

- Each waveform (or symbol representing a set of input bits) is obtained from a different circular cyclic integer shift of the fundamental PRN code.

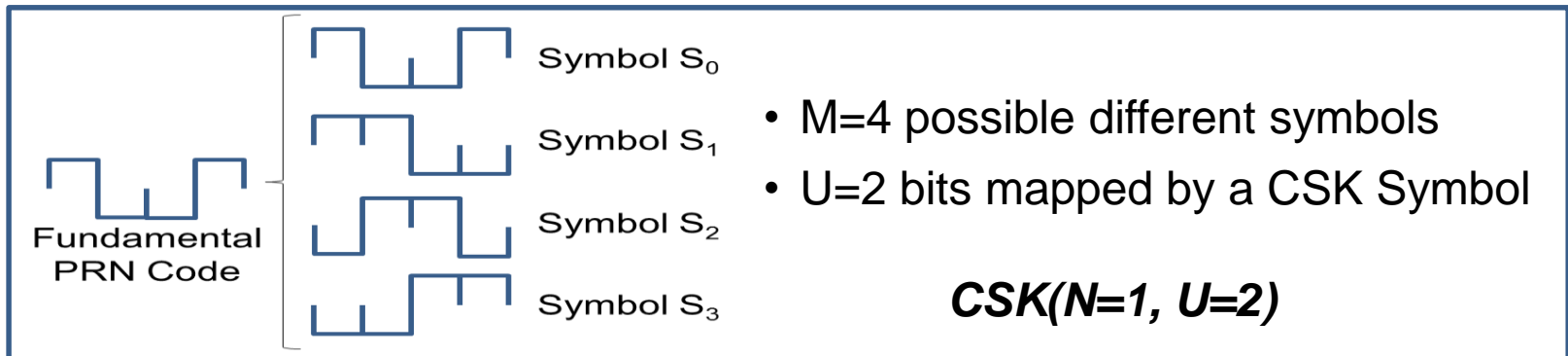

➤ Increase of the bit rate by a factor of U with respect to a BPSK modulation.

- CSK Configuration (N,U): 'N' consecutive and identical PRN code shifts, with 'U' bits mapped by each PRN code shift, are used to create the CSK symbol



➤ Increase of the bit rate by a factor of (U/N) with respect to a BPSK modulation.

7. Code Shift Keying (CSK) modulation (2/6)

Why is CSK modulation useful?

- Objectives:
 - Increase the signal data rate
 - Demodulation of the navigation message in suburban/urban/indoor environments

CSK vs BPSK modulation for increasing the data rate:

| | | |
|-------------|--|---|
| BPSK | Symbol rate must be increased | 1) If chip rate is maintained, PRN code length is decreased → Loss of PRN orthogonal properties |
| | | 2) If PRN code length is maintained, chip rate is increased → Signal bandwidth increase |
| CSK | Chip rate and PRN code length are maintained. Symbol rate is maintained or decreased | |

CSK vs BPSK modulation in harsh environments:

| | | |
|-------------|---|--|
| BPSK | Only coherent demodulation is possible | A PLL is unable to estimate the carrier phase for low C/N_0 values and fast carrier phase variations |
| CSK | Coherent and non-coherent demodulation are possible | |

7. Code Shift Keying (CSK) modulation (3/6)

CSK characteristics: Demodulator

- Demodulator of an orthogonal M-ary modulation implements a bank of matched filters, one filter for each symbol
- The matched filter with the largest output value determines the transmitted symbol

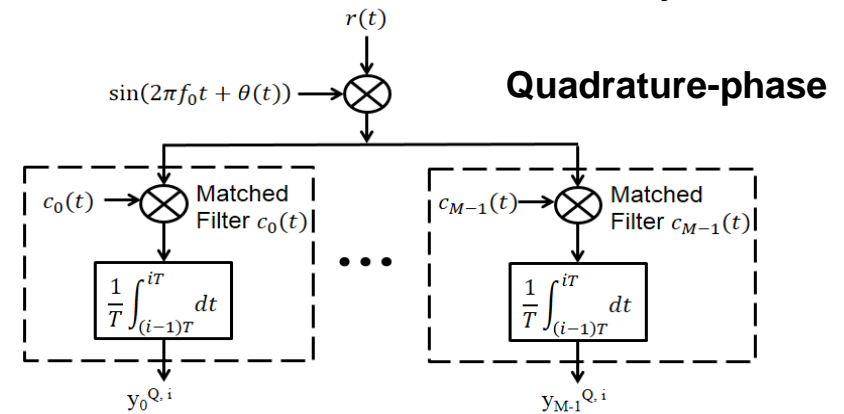
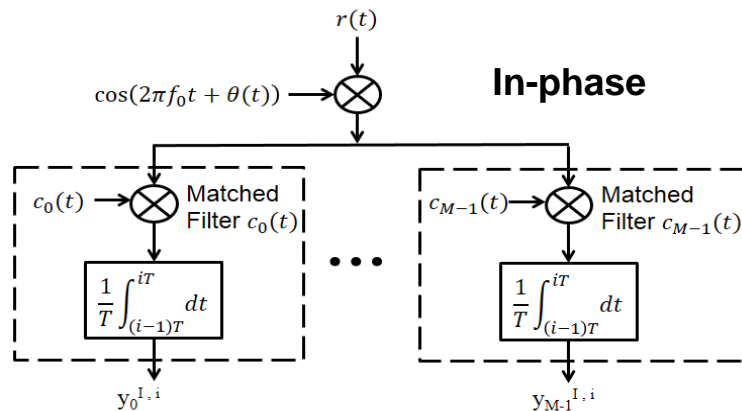

1) Coherent demodulator:

- Vector $Y^{I,i} = \{y_0^i, \dots, y_{M-1}^i\}$ is used to determine which symbol has been used

2) Non-coherent demodulator:

- Vector $|Y^i| = \{|y_0^i|, \dots, |y_{M-1}^i|\}$ is used to determine which symbol has been used

$$|y_k^i| = \sqrt{(y_k^{I,i})^2 + (y_k^{Q,i})^2}$$



Carrier phase influence is removed by obtaining the module

7. Code Shift Keying (CSK) modulation (4/6)

CSK characteristics: Coherent demodulation performance in an AWGN channel

- Different couples channel code/decoding methods can be implemented:

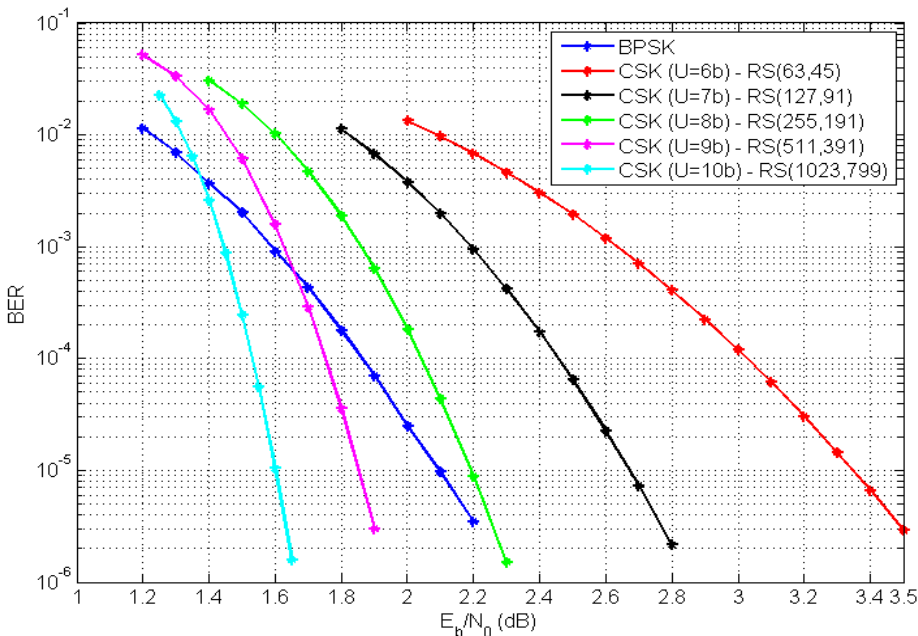

BER vs E_b/N_0 for a reference BPSK signal and for a CSK signal with Reed-Solomon Channel Codes

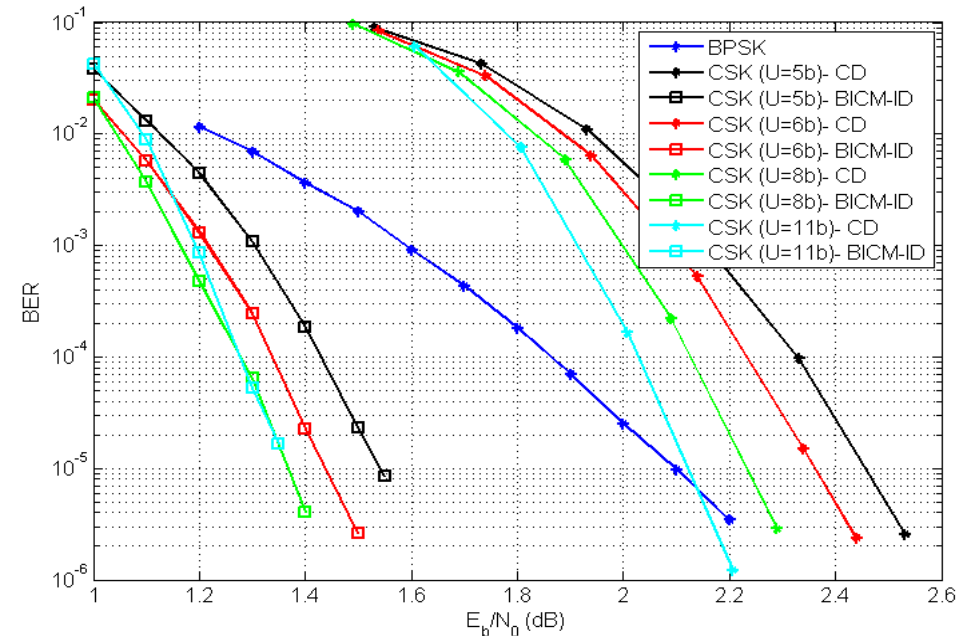

BER vs E_b/N_0 for a reference BPSK signal and for a CSK signal using GPS L1C subframe 2 LDPC, CD and BICM-ID decoding methods and Mapping A

- CSK configuration ($N=U/n, U$), with the possible largest U value, provides the best demodulation performance when the data rate is increased by a factor of ' n '.
- However, the codeword duration increases along with $N=U/n$

7. Code Shift Keying (CSK) modulation (5/6)

CSK characteristics: Non-coherent demodulation performance in a mobile channel

- BER vs data $C_{\text{pre-urban}}/N_0$ for different CSK configurations (U/n,U), x2 bit rate increase
- The simulated mobile Channel is the Perez-Fontan model without change of states

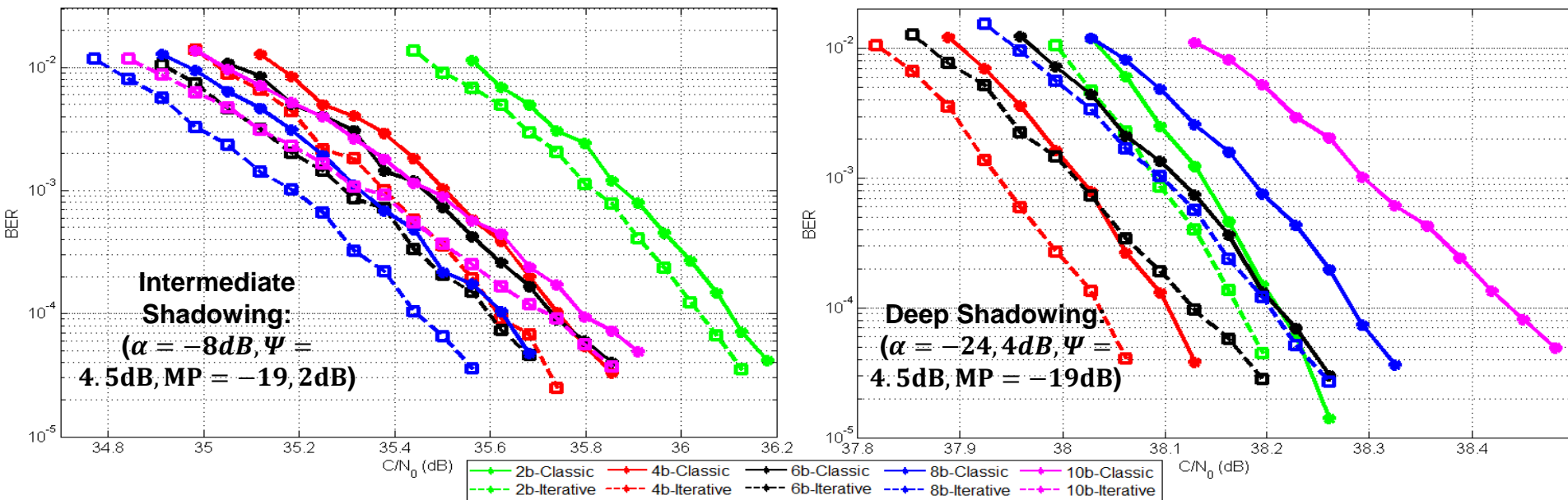

- CSK modulated signal can be non-coherent demodulated even for harsh conditions
- Due to the carrier phase variations, CSK configurations (U/n,U) with larger U values do no longer provide the best demodulation performance

7. Code Shift Keying (CSK) modulation (6/6)

CSK Drawbacks:

1. The data component cannot be used to acquire or track the signal → Requires a pilot component
2. The complexity of the receiver increases

CSK Advantages:

1. Possibility of implementing a non-coherent demodulation → no need to have carrier phase lock
2. Increase of the useful data rate without modifying the symbol data rate, the chip rate and the PRN code length as opposite to BPSK modulation.
3. Flexibility of the useful data rate → Dynamic change of the number of bits mapped by a CSK symbol.

Outline

1. Navigation Message Evolution
2. New demodulation performance methodology in mobile channels
3. Code Shift Keying (CSK) modulation
4. **GNSS Signal with variable data rate**

8. GNSS Signal with variable data rate (1/5)

Motivation: The different types of information data transmitted by a GNSS or SBAS system does not have the same level of importance.

- For a GNSS:
 - Essential information to calculate the user PVT: Ephemeris and Clock Error correc.
 - Additional information such as ionosphere and troposphere corrections are important but not mandatory
- For a SBAS:
 - Integrity information is the most critical information and occupies the majority of the bandwidth (UDREi in current SBAS L1).
 - Satellite long corrections are important but the receiver could still use the SBAS system if some are lost
- Additional services could be transmitted if more bandwidth was available:
 - GNSS example: Precise positioning
 - SBAS example: Information to reach CAT II approach



8. GNSS Signal with variable data rate (2/5)

Example of GNSS/SBAS signal structure with variable data rate:

- Fundamental idea:
 - The signal is always divided in fixed blocks of known length, T_{Block} (e.g. 1s)
 - The characteristics/configuration of each fixed length block varies are/is provided by a signal component or by a pre-planned schedule
- Proposed signal is constituted of 4 components:
 - 1) **Pilot component** → In charge of tracking, acquiring and synchronizing the fixed length blocks
 - 2) **Primary Data component** → BPSK modulated
 - 3) **Secondary Data component** → BPSK/CSK modulated with different CSK configurations
 - 4) **Configuration component (or pre-planned schedule)** → In charge of providing the fixed length block configuration of the primary and secondary data components

8. GNSS Signal with variable data rate (3/5)

Shared property among all signal components:

- All signal components have a different and synchronized primary PRN code of the same period $T_{PRN,p}$

Pilot component structure:

- Secondary code, PRN_A , of period equal to T_{Block} , each chip is one primary PRN code

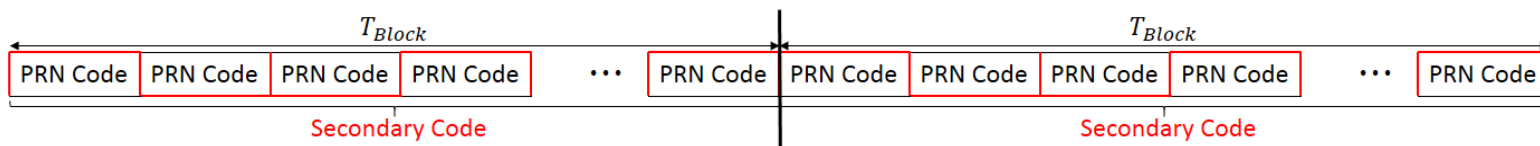

Configuration component structure:

- Secondary code, PRN_B , of period equal to T_{Block} , each chip is 1 primary PRN code
- A (1, U) CSK modulation is applied over the secondary code in order to transmit the data components configuration of the next fixed block length data components.

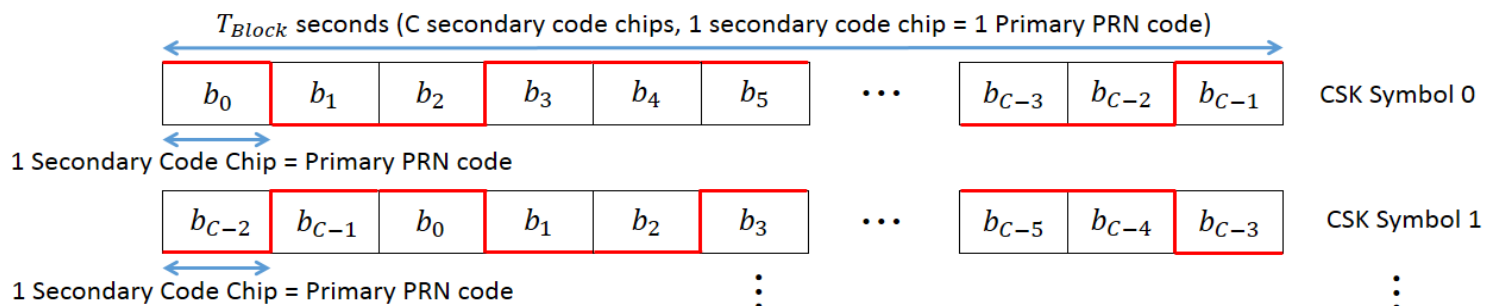

8. GNSS Signal with variable data rate (4/5)

Primary Data component structure:

- Each T_{Block} block carries a BPSK modulated signal with constant data rate (BPSK symbol = 1 PRN code)

Secondary Data component structure:

- Each T_{Block} block is dynamically BPSK-CSK modulated. It carries either:
 - A BPSK modulated signal with constant data rate (BPSK symbol = 1 PRN code)
 - Or a (N,U) CSK configuration where U and N depends on the configuration

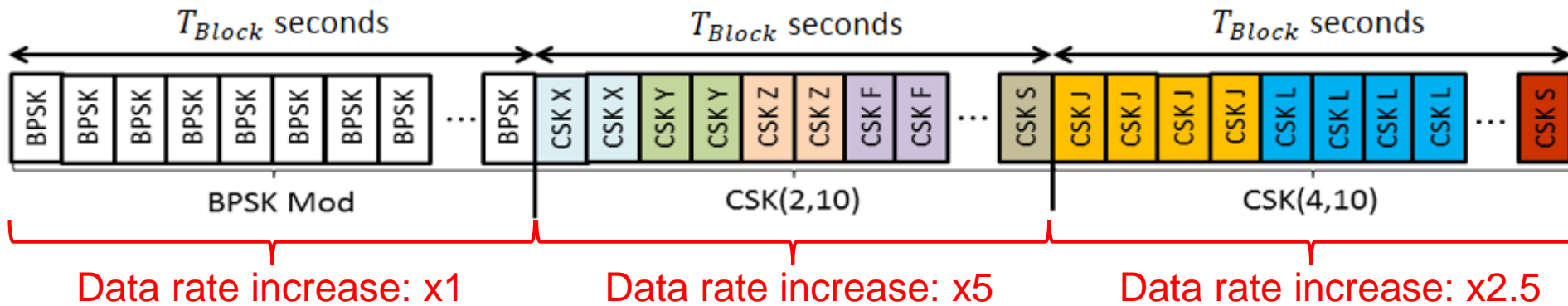

8. GNSS Signal with variable data rate (5/5)

Example:

Configuration Component

| | | | | |
|------------------|----------------------------|-----------------------|----------------------------|------------------|
| Config CSK(4,10) | Config Large Message (1/2) | Config Shared Message | Config Large Message (2/2) | Config CSK(2,10) |
|------------------|----------------------------|-----------------------|----------------------------|------------------|

Primary Data Component

| | | | | |
|-----------------|-----------------|-----------------------|----------------|-----------------------|
| Short Message A | Short Message B | Large Message A (1/2) | Shared Message | Large Message A (2/2) |
|-----------------|-----------------|-----------------------|----------------|-----------------------|

Secondary Data Component

| | | | | |
|-----------|-----------|-----------------------|----------------|-----------------|
| CSK(2,10) | CSK(4,10) | Large Message A (2/2) | Shared Message | Short Message C |
|-----------|-----------|-----------------------|----------------|-----------------|

Coherent Accumulation

Additional advantages:

- In order to further increase/decrease the data rate and thus to further decrease/increase the message robustness:
 - Combination of data message transmitted at the same time on both components
 - Channel Coding varies depending on the configuration
- A codeword can span more than one fixed length block
- The current message can be interrupted → An alarm can be emitted each T_{Block} seconds

Proposal for future GNSS/SBAS signal/message

- To design a GNSS/SBAS signal/message with a variable data rate in order to better adapt the message robustness to the information importance level
- To use selectively the CSK modulation in some components of the new signal/message
- To use different channel codes to protect the different types of information
- To use the new proposed methodology for analyzing GNSS signals demodulation performance in mobile channels in order to define a new signal which meets the high level operational requirements

Thank you for your attention

Axel GARCIA-PENA: garcia-pena@recherche.enac.fr



ECOLE NATIONALE DE L'AVIATION CIVILE

TELECOM LAB -
SIGNAL PROCESSING AND
NAVIGATION RESEARCH
GROUP

BACK-UP SLIDES

1. Navigation message GPS L1 C/A (1/4)

Integrity (1/2):

- GPS L1 C/A message integrity is controlled by an extended Hamming code (32,26)
- Since each codeword is constituted of 30 bits, 2 bits of the previous word must be used to encoded and decoded the codeword

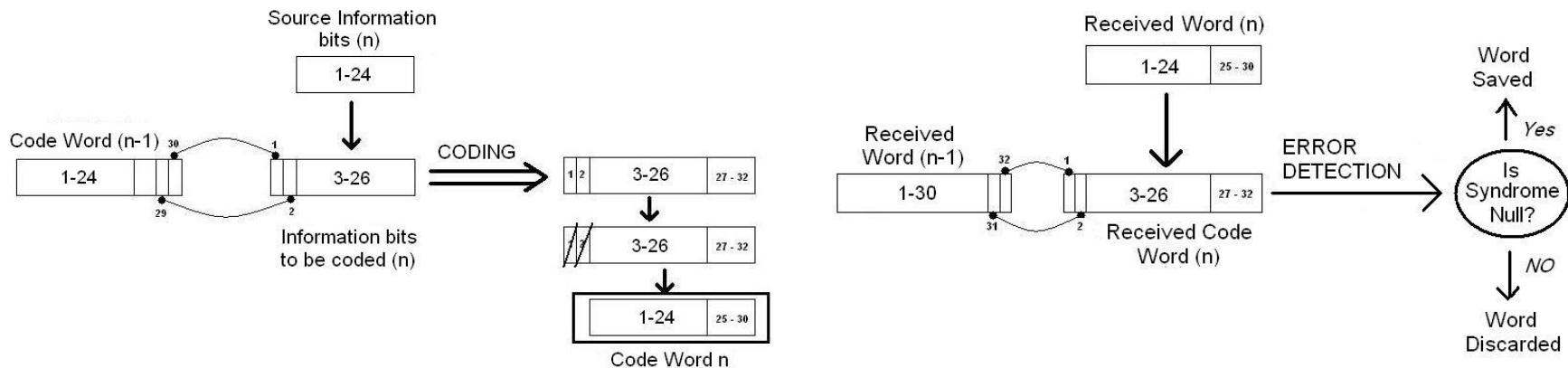

- Theoretically, this code can detect up to 2 errors with a 100% probability
- Theoretically, the probability of not being able to detect an error is:

$$P_d = \frac{\text{num codewords}}{\text{num combinations received bits}} = \frac{2^{26}}{2^{32}} = 2^{-6} = \text{ecrire}$$

1. Navigation message GPS L1 C/A (2/4)

Integrity (2/2):

- However, due to the sharing of the last 2 bits between consecutive words, the final integrity will depend on the receiver strategy
 - Example: If Codeword n is detected as erroneous, last 2 bits of codeword $(n - 1)$ could be erroneous and thus codeword $(n - 1)$ is also considered as erroneous

Carrier Phase ambiguity for demodulation:

- EH(32,26) code is not systematic: bit 30 of codeword $(n - 1)$ controls the polarity of information bits of codeword n .
- Due to the non systematic property, EH(32,26) is transparent to the carrier phase jumps of π (except for the first word).

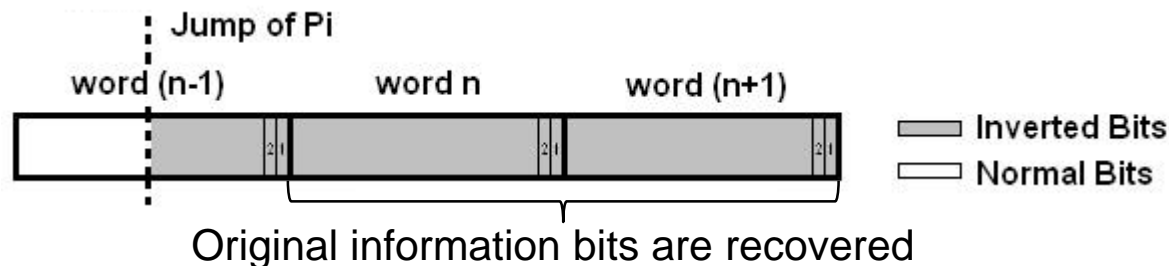

1. Navigation message GPS L1 C/A (3/4)

Message Content Repetition

- Some message content is repeated: Ephemeris, Clock Error corrections, etc.
- Since there is not an implemented FEC, two bits which a priori contain the same information can be coherently accumulated.
- Nevertheless, due to the non-systematic property of EH(32,23) code it is very difficult to guarantee that bits containing the same information have the same value
- The coherent accumulation remains marginal

Message Content Distribution

- Since there is no implemented FEC, the number of subframes carrying the ephemeris does not matter.

Subframe synchronization:

- Subframe synchronization process is achieved by using some bits of the 1st (Preamble) and 2nd (TOW) codeword of each subframe
- However, these bits are not protected by any FEC → Less robust to the noise

1. Navigation message GPS L1 C/A (4/4)

Bit synchronization:

- Bit synchronization is necessary prior to subframe synchronization since 20 PRN codes span 1 data symbol.

1b. Navigation message GPS L2C and L5 (1/5)

Information Message Structure:

- Continuous stream of information messages.
- Each message is constituted of 300 bits: 276 information bits and 24 parity bits
- First information bits are: 8b preamble, 6b SV Id, 6b Message Id
- Flexible structure: Message contents (or Id) are determined by time outs

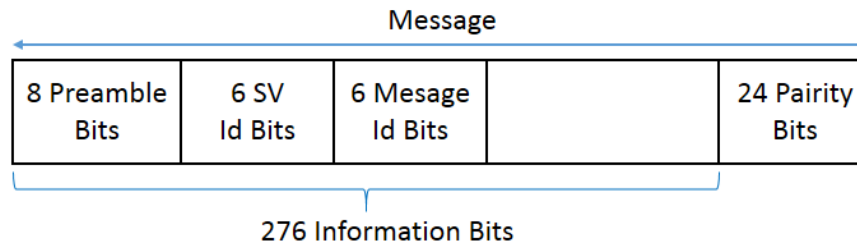

Message structure sent to the channel:

- The continuous stream of information messages are fed to an encoder block
- The output of the encoder block is sent (after BPSK modulation) to the channel



1b. Navigation message GPS L2C and L5 (2/5)

Forward Error Correction (FEC):

- Referred as Inner channel code, it is a convolutional channel code (CC):

| Code rate | Polynomial Generators | | Constraint Length | Minimum free distance |
|-----------|-----------------------|----------|-------------------|-----------------------|
| $r = 1/2$ | G1 = 171 | G2 = 133 | L = 7 | $d_{free} = 10$ |

- Therefore, each information word is converted into 600 coded bits.
- A continuous stream of bits is broadcast to the channel
- Traditional decoding method is the Viterbi Algorithm
- The introduction of a CC makes the navigation message more robust to the noise:

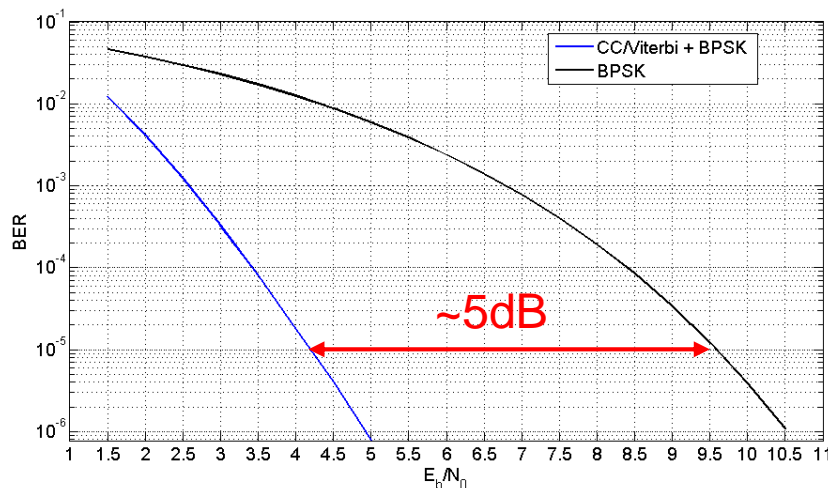

➔ For a BER= 10^{-5} , about 5dB less will be required

1b. Navigation message GPS L2C and L5 (3/5)

Integrity (1/2): GPS L2C (synthesiser)

- GPS L2C message integrity is controlled by a Cyclic Redundancy Code, CRC-24Q, which generates the 24 parity bits of the information message from its 276 info bits.
- CRC-24Q performance:
 - It detects all single bit, double bit and any odd number of errors per code word
 - It detects any burst error for which the length of the burst is ≤ 24 bits.
 - The fraction of error bursts of length $b > 24$ that are undetected is:
 - $P_D = 2^{-23} = 1.19 \times 10^{-7}$, if $b = 25$ bits.
 - $P_D = 2^{-24} = 5.96 \times 10^{-8}$, if $b > 25$ bits.
- To calculate the final integrity performance, the CC output pattern must be taken into account since the CRC-24Q verification is applied on this output.
- Whenever a CC commits an error during the correction process, CC will output a pattern of errors (consecutive bit errors) instead of independent errors.
- Besides, the error burst occurrence probability is inversely proportional to its length, b ,
- Therefore, the combination of a CC and a CRC is very interesting because, for short information words, the majority of CC output errors will be detected since $b \leq 24$ bits

1b. Navigation message GPS L2C and L5 (4/5)

Integrity (2/2): Comparison GPS L2C and GPS L1 C/A

- Although GPS L1 C/A integrity depends on the receiver strategy, GPS L2C integrity is more robust even for the example given before.
- The percentage of integrity dedicated bits is lower for GPS L2C than for GPS L1 C/A
- Whereas EH(32,26) imposes the information bits being protected, CRC-24Q does not.
- However, the integrity is better checked with a small number of information bits and the combination with a CC emphasizes this fact.

Carrier Phase ambiguity for demodulation:

- Since GPS L2C implements a pilot component, the carrier phase ambiguity for demodulation is removed

Message Content Repetition

- Since GPS L2C has a flexible structure and the message must be decoded before knowing its ID, the coherent accumulation is not possible.

1b. Navigation message GPS L2C and L5 (5/5)

Message Content Distribution

- Ephemeris and Clock Error Corrections are distributed into 2 messages
- This separation into 2 messages is mandatory due to the use of CC

Message synchronization:

- Message synchronization process can be achieved by using the preamble bits, SV Id bits and integrity check (CRC-24Q verification).

Bit synchronization:

- GPS L2C:
 - Bit synchronization is directly achieved since 1 PRN code spans 1 data symbol
 - However, synchronization with Viterbi decoder must be achieved for decoding
- GPS L5:
 - Bit synchronization achieved with data component secondary code
 - Synchronization with Viterbi achieved with pilot component secondary

1c. Navigation message GALILEO E1 OS (1/2)

Information Message Structure:

- Continuous stream of frames, where each frame is constituted of 24 subframes
- Each subframe is constituted of 15 pages (or words)
- Each page (or word) is constituted of two page parts

Subframe:

| T_0 (GST ₀ sync.) (s) | E1-B Content | | | | | | E1-B Page | E1B Sub frame ID |
|---|--------------------|------|-------|-------|------|------|--------------|---------------------------|
| 0 | Spare Page (2/2) | Res. | SAR | Spare | CRC | Res. | Odd | N-1 |
| 1 | Page 2 (1/2) | | | | | | Even | N |
| 2 | Page 2 (2/2) | Res. | SAR | Spare | CRC | Res. | Odd | N |
| 3 | Page 4 (1/2) | | | | | | Even | N |
| 4 | Page 4 (2/2) | Res. | SAR | Spare | CRC | Res. | Odd | N |
| 5 | Page 6 (1/2) | | | | | | Even | N |
| 6 | Page 6 (2/2) | Res. | SAR | Spare | CRC | Res. | Odd | N |
| 7 | Page 7 or 9 (1/2) | | | | | | Even | N |
| 8 | Page 7 or 9 (2/2) | Res. | SAR | Spare | CRC | Res. | Odd | N |
| 9 | Page 8 or 10 (1/2) | | | | | | Even | N |
| 10 | Page 8 or 10 (2/2) | Res. | SAR | Spare | CRC | Res. | Odd | N |
| 11 | Reserved (1/2) | | | | | | Even | N |
| 12 | Res. (2/2) | SAR | Spare | CRC | Res. | | Odd | N |
| 13 | Reserved (1/2) | | | | | | Even | N |
| 14 | Reserved (2/2) | SAR | Spare | CRC | Res. | | Odd | N |

| T_0 (GST ₀ sync.) (s) | E1-B Content | | | | | | E1-B Page | E1B Sub frame ID |
|---|------------------|------|-------|-------|------|------|--------------|---------------------------|
| 15 | Reserved (1/2) | | | | | | Even | N |
| 16 | Reserved (2/2) | SAR | Spare | CRC | Res. | | Odd | N |
| 17 | Reserved (1/2) | | | | | | Even | N |
| 18 | Reserved (2/2) | SAR | Spare | CRC | Res. | | Odd | N |
| 19 | Reserved (1/2) | | | | | | Even | N |
| 20 | Reserved (2/2) | SAR | Spare | CRC | Res. | | Odd | N |
| 21 | Page 1 (1/2) | | | | | | Even | N |
| 22 | Page 1 (2/2) | Res. | SAR | Spare | CRC | Res. | Odd | N |
| 23 | Page 3 (1/2) | | | | | | Even | N |
| 24 | Page 3 (2/2) | Res. | SAR | Spare | CRC | Res. | Odd | N |
| 25 | Page 5 (1/2) | | | | | | Even | N |
| 26 | Page 5 (2/2) | Res. | SAR | Spare | CRC | Res. | Odd | N |
| 27 | Spare Page (1/2) | | | | | | Even | N |
| 28 | Spare Page (2/2) | Res. | SAR | Spare | CRC | Res. | Odd | N |
| 29 | Spare Page (1/2) | | | | | | Even | N |
| 30 | Spare Page (2/2) | Res. | SAR | Spare | CRC | Res. | Odd | N |

Page Part 1

| Even/odd=0 | Page Type | Data j (1/2) | Tail | Total (bits) |
|------------|-----------|--------------|------|--------------|
| 1 | 1 | 112 | 6 | 120 |

Page Part 2

| Even/odd=1 | Page Type | Data j (2/2) | Reserved 1 | SAR | Spare | CRC _j | Reserved 2 | Tail | Total (bits) |
|------------|-----------|--------------|------------|-----|-------|------------------|------------|------|--------------|
| 1 | 1 | 16 | 40 | 22 | 2 | 24 | 8 | 6 | 120 |

Page (or word):

1c. Navigation message GALILEO E1 OS (2/2)

Forward Error Correction (FEC):

- The same channel code as GPS L2C is used to implement the FEC: CC(171,133)
- Difference: 6 tail bits are inserted at the end of each page part
 - Preamble bits are no longer protected by the FEC (with respect to GPS L2C)
 - Allows the implementation of an interleaver

Interleaver:

- Rectangular interleaver with dimensions, (30 columns x 8 rows), applied to 1 page
- Function: To make the navigation message more robust to its transmission through a mobile channel by breaking the burst of errors introduced by the channel

Receiver processing difference between GPS L2C and GALILEO E1 OS:

- GPS L2C:
 - 1) Decoding the received stream of bits
 - 2) Achieving message synchronization
- GAL E1 OS:
 - 1) Achieving page part synchronization
 - 2) De-interleaving + Decoding the bits of page part

1d. Navigation message GPS L1C (1/2)

Forward Error Correction (FEC):

- Subframe 1 is encoded with an extended BCH(52,9) with minimum distance, $d_{min}=20$
- Subframe 2 is encoded with a LDPC(1200,600) and subframe 3 with a LDPC(548,274)
- LDPC are very powerful codes which obtain near shanon limit performance
- Both LDPC codes and BCH(52,9) obtain better demodulation performance than the CC(171,133)

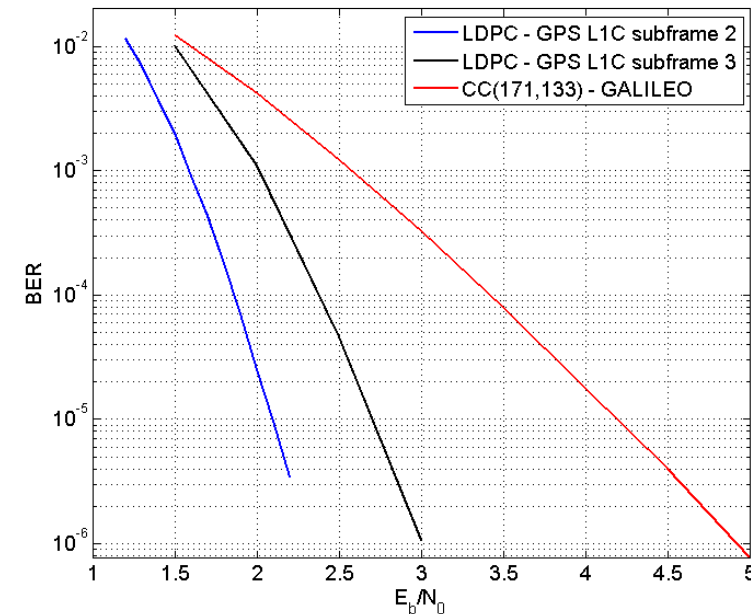

Interleaver:

- Subframe 2 and subframe 3 interleaved together (38 rows x 46 columns) interleaver
- Breaks larger burst of errors than GALILEO E1 OS interleaver and distributes the errors into two subframes

Frame synchronization:

- Frame synchronization is achieved with the pilot component secondary code

1d. Navigation message GPS L1C (2/2)

Message Content Repetition

- For the first time, the complete information content of a subframe is repeated AND the resulting encoded subframe is the same for a known period of time.
 - Exact subframe 2 replicas are repeated for 2 hours
- Subframe 2 replicas can be coherently accumulated and thus the received C/N₀ is increased with each accumulation:

$$\text{Gain } C/N_0 = 10 \log_{10}(\text{number of accumulated subframes})$$

Message Content Distribution

- For the first time, CED is carried on the same subframe
- In AWGN channel, this property provides additional robustness since just one codeword/subframe/message must be decoded.

6. New demodulation Performance methodology (1/3)

Proposition:

- Separating the reception message conditions into favorable reception conditions and unfavorable reception conditions
- Providing demodulation performance for favorable reception conditions
- Providing the occurrence rate: Statistical information about the occurrence of the message favorable reception conditions.

Occurrence rate:

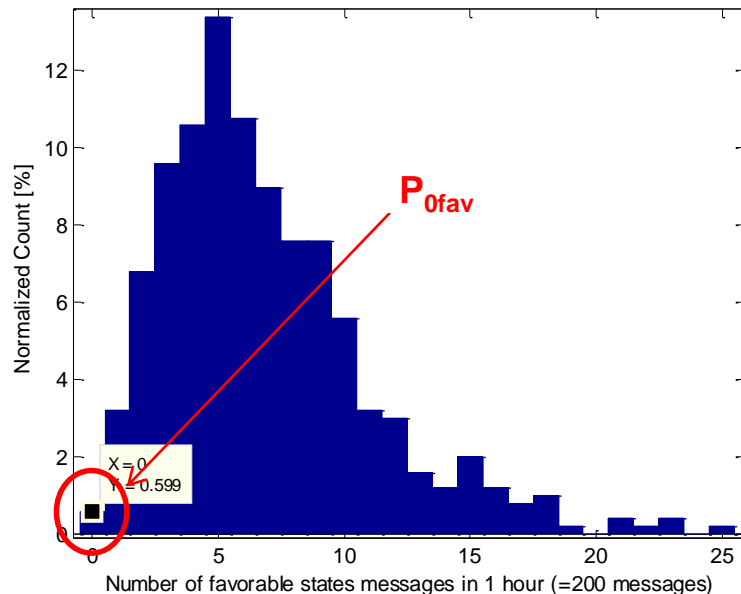

- P_{0fav} : No 'favorable state message' has occurred during the interval of interest T_{occ}
- Key point: To define a criterion which provides the 'favorable state messages' having the best possible demodulation performance (work to do).

Favorable state occurrence rate, $T_{occ} = 2h$, for GPS L1C frame using the Prieto channel model with 40° of elevation considering the Prieto channel
GOOD states as favorable reception conditions

6. New demodulation Performance methodology (2/3)

- Methodology until now: providing the Error Rate (ER) of a given data set as a function of the signal $C_{\text{pre-urban}}/N_0$ only for determined favorable reception conditions and providing the statistical occurrence values of these conditions
- Remaining question: Which statistical occurrence values are considered acceptable?
 - Determined by the operational requirements

Link between the statistical occurrence/Error Rate and operational requirements

- Low level requirements are defined to achieve this link: reception of a given data set by 1 single satellite during a continuous period of time.
- Minimum Required Availability (MRA): The couple GNSS signal/receiver meets the MRA requirement if with probability P_{mra} , the receiver receives at least ONE data set in a given time T_{mra} , associated to a data set error rate ER_{mra} .
- Absolute Minimum Required Availability (AMRA): Couple GNSS signal/receiver meets the AMRA requirement if with probability P_{amra} , the receiver is able to successfully demodulate at least ONE data set in a given time T_{amra} , for a $C_{\text{pre-urban}}/N_0_{amra}$ value

6. New demodulation Performance methodology (3/3)

- Methodology Example:

* 4 satellites with 40° elevation

| <i>New Methodology</i> | <i>Example</i> |
|--|--|
| High level operational requirement | To determine if a GPS L1C receiver can calculate a continuous valid position during 4 consecutive hours, with a probability greater than 95% |
| Step 0: Determining MRA (P_{mra} , T_{mra} and ER_{mra}) from the high level operational needs. | MRA ($P_{mra} = 0,9936$, $T_{mra} = 1h$ and $ER_{mra} = 10^{-2}$)* |
| Step 1: Determining $P_{ofav, max}$ | $P_{ofav, max} = 0,0064$ |
| Step 2: Searching the favorable reception conditions which induces $P_{ofav, max}$ | Messages entirely received in GOOD states of Prieto model are considered as received in favorable reception conditions* |
| Step 3: Calculating the data error rate only for the data sets of interest contained in these 'favorable state messages'. | $CEDER = 10^{-2}$ for a $C_{pre-urban}/N_0 = 26.5 \text{ dB} - \text{Hz}$ |
| Step 4: Determining a bound on AMRA | $P_{amra} \geq 0,953$ for $C_{pre-urban}/N_0 = 26.5$ |

7. Code Shift Keying (CSK) modulation (1/3)

CSK characteristics: Codeword source mapping

- Mapping between the bits carried by a CSK symbol and the codeword bits
 - Determines the codeword duration and the signal demodulation performance.
 - Mapping A: Each bit mapped by a symbol belongs to a different codeword.
 - Mapping B: All the bits mapped by a symbol belong to the same codeword.

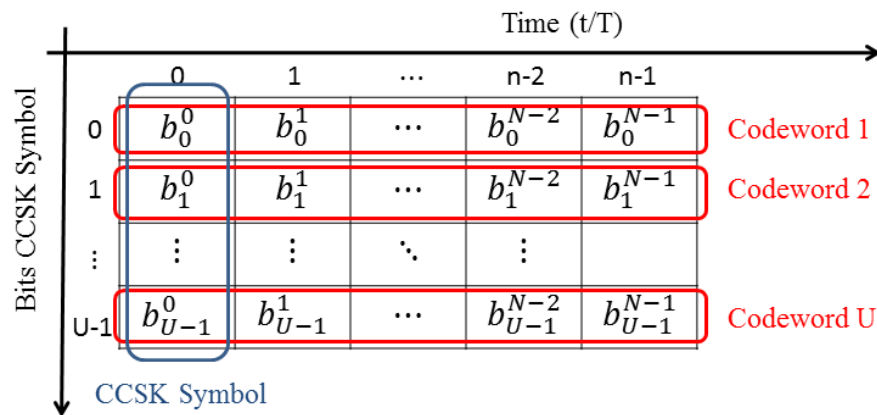

Mapping A

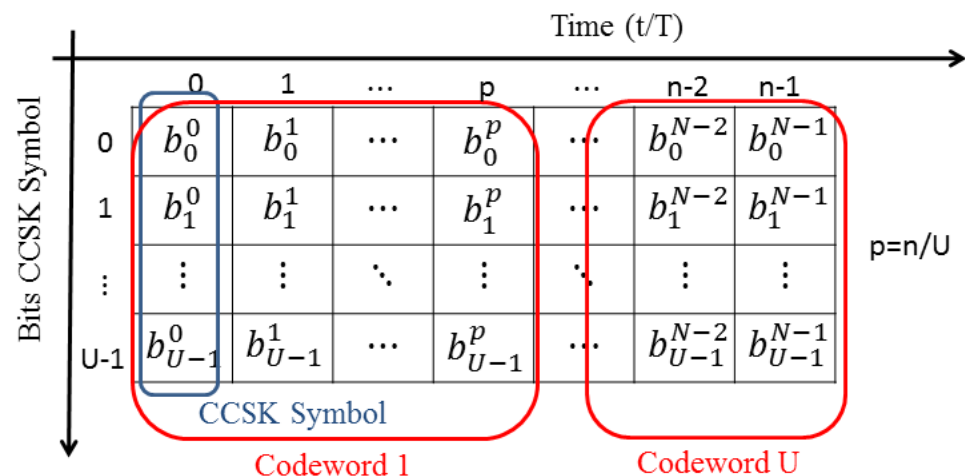

Mapping B

- Mapping A provides better demodulation performance with a longer codeword duration
- Mapping B has worse demodulation performance with a shorter codeword duration

7. Code Shift Keying (CSK) modulation (2/3)

CSK characteristics: Decoding

- The different channel codes and its associated decoding methods will play a very important role on the final signal structure design
 1. Determine the demodulation performance
 2. Determine the receiver's complexity
 3. Determine the codeword duration
- Final choice will be a trade-off between the previous 3 factors and the signal needs.
- Couple Channel Codes/ Decoding methods:

| Channel Code | Decoding Method |
|-----------------------------|---|
| GPS L1C subframe 2 LDPC | Classical CSK decoding method (CD) |
| | Bit-Interleaved Coded Modulation – Iterative Decoding (BICM-ID) |
| Q-ary code: Reed-Solomon | Berlekamp / Forney algorithm |

7. Code Shift Keying (CSK) modulation (3/3)

CSK characteristics: Demodulation performance for increased data rates in AWGN

- Coherent demodulation: BER vs C/N_0 and codeword duration for a CSK signal when increasing the data rate of a BPSK modulated signal with a PRN code of $T_s = 4\text{ms}$
- Characteristics:
 - Mapping A and B
 - Channel Coding: GPS L1C subframe 2
 - CD and BICM-ID decoding methods
 - Only 1 ($N=1$) accumulated PRN code

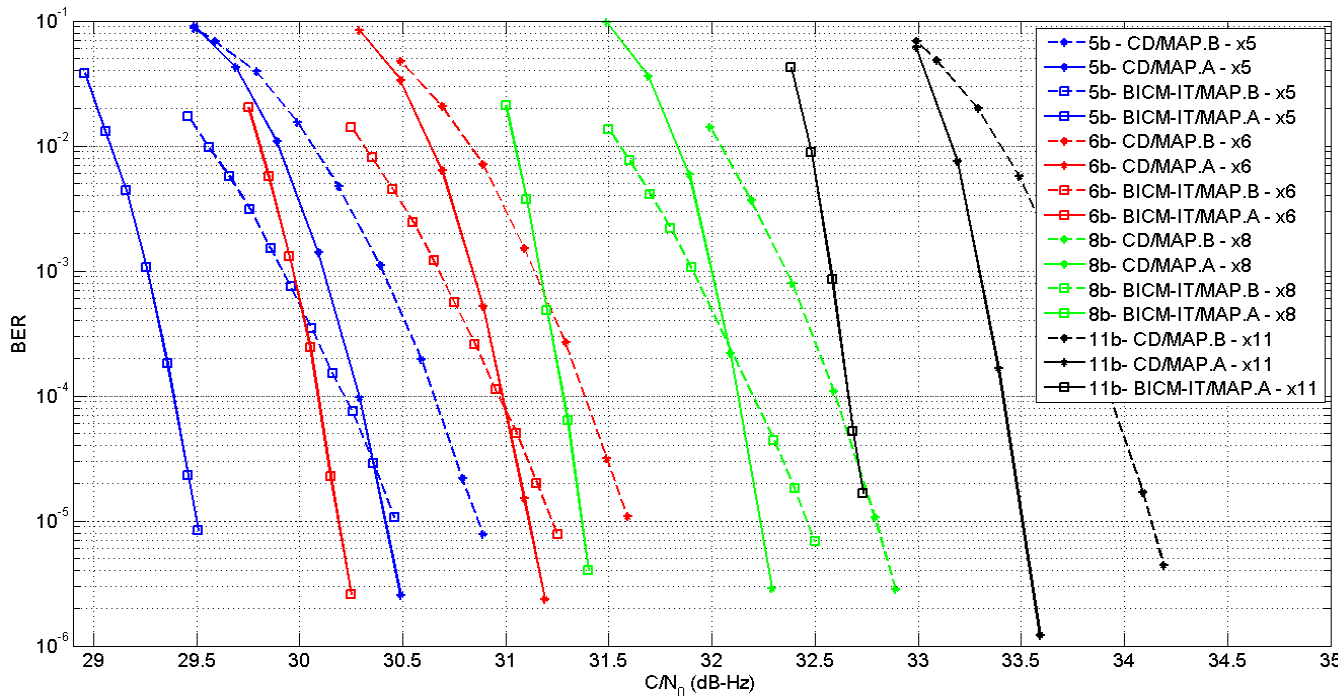

| Codeword Duration | | Map A |
|-------------------|----|---------------------------------|
| Bits per symbol | 5 | $1200 \cdot N \cdot T_s$ |
| | 6 | |
| | 8 | |
| | 11 | |
| | 12 | |
| | | Map B |
| Bits per symbol | 5 | $240 \cdot N \cdot T_s$ |
| | 6 | $200 \cdot N \cdot T_s$ |
| | 8 | $150 \cdot N \cdot T_s$ |
| | 11 | $\approx 110 \cdot N \cdot T_s$ |
| | 12 | $100 \cdot N \cdot T_s$ |