



**HAL**  
open science

## Towards a long endurance MAV

Murat Bronz, Jean-Marc Moschetta, Pascal Brisset, Michel Gorraz

► **To cite this version:**

Murat Bronz, Jean-Marc Moschetta, Pascal Brisset, Michel Gorraz. Towards a long endurance MAV. EMAV 2009, European Micro Aerial Vehicle Conference and Flight Competition, Sep 2009, Delft, Netherlands. pp 241-254. hal-01022516

**HAL Id: hal-01022516**

**<https://enac.hal.science/hal-01022516>**

Submitted on 31 Oct 2014

**HAL** is a multi-disciplinary open access archive for the deposit and dissemination of scientific research documents, whether they are published or not. The documents may come from teaching and research institutions in France or abroad, or from public or private research centers.

L'archive ouverte pluridisciplinaire **HAL**, est destinée au dépôt et à la diffusion de documents scientifiques de niveau recherche, publiés ou non, émanant des établissements d'enseignement et de recherche français ou étrangers, des laboratoires publics ou privés.

# **Towards a Long Endurance MAV**

**Murat Bronz, Jean Marc Moschetta, Pascal Brisset, Michel Gorraz**

Reprinted from

## International Journal of **Micro Air Vehicles**

Volume 1 · Number 4 · December 2009



**Multi-Science Publishing**  
**ISSN 1756-8293**

# Towards a Long Endurance MAV

Murat Bronz<sup>\*</sup>, Jean Marc Moschetta<sup>†</sup>, Pascal Brisset<sup>‡</sup>, Michel Gorraz<sup>§</sup>

Institut Supérieur de l'Aéronautique et de l'Espace, University of Toulouse, France  
and Ecole Nationale de l'Aviation Civile, Toulouse, France

May 2009

## ABSTRACT

A conceptual design and performance analysis method (**Long Endurance Conceptual Design Program**) for long-endurance mini-micro UAVs is presented. Recent long endurance oriented results and achievements are looked through for possible usage for mini-micro scale. A real mission is also explained, whose objective is to accomplish a 200 km straight line flight autonomously with the smallest electric platform possible. Design phases of the platform by using the presented method, flight tests and comparison of the results are included. On the following section a design study for long-endurance MAVs using a hybrid energy system combining solar energy and Lithium batteries and the effect of size and cruise speed are investigated. We demonstrate that under a certain size, the use of solar energy becomes not useful at all. We conclude with the study of a candidate design for EMAV09 Endurance Mission in the light of the rules and scoring of the mission.

**Keywords:** Long Endurance, Solar Power, System Design and Optimization, Paparazzi Autopilot

## 1. INTRODUCTION

The number of the fields are increasing day by day which UAVs can take part in, but all of these fields have different and additional demands for their particular mission. These are pushing the limits of the UAVs to extremes by all means of disciplines such as structure, electronics, aerodynamics etc. Of course the operational costs are usually among the most important issues. By the help of miniaturization of the on-board electronics, it has become much more feasible to shrink the size of the UAVs which brings cost advantages and operational simplicity as well.

The biggest problem for small UAVs is the energy source which is not small enough to achieve the same endurance as the big ones. For sure, long endurance capability is needed and is a big advantage for any kind of mission. So we concentrate our effort on having a long-endurance mini-micro UAV.

This paper will present the initial approach for a Long-endurance mini-micro UAV conceptual design, by introducing the method and the **Long Endurance Conceptual Design Program** behind, some ideas for extracting energy which are planned for future work, candidate energy sources that are decided to be used, an example mission which was chosen for coefficient verification of the design program, and also the feasibility study of using the above techniques for MAV design. In the last part a candidate design for EMAV09 Endurance Mission will be studied with the rules and scoring in mind.

## 2. DESIGN STUDY FOR A LONG-ENDURANCE MINI-UAV

The Design process has several phases, like conceptual, preliminary and detailed design. Generally in the conceptual design phase of a UAV, a wide competitor-study according to the type of the mission can lead to quite close results for the geometrical specifications of the design, which will be frozen on the final design. However on a design like long-endurance mini-UAV, as the concept is novel, a competitor-study will either not be sufficient or not lead to an innovative design.

---

<sup>\*</sup>PhD Student, Murat.Bronz@isae.fr

<sup>†</sup>Professor in Aerodynamics, Jean-Marc.Moschetta@isae.fr

<sup>‡</sup>Lecturer in Computer Science, Pascal.Brisset@enac.fr

<sup>§</sup>Lecturer in Electronics, Michel.Gorraz@enac.fr

So the key points of the challenge for a long-endurance Mini-UAV have been investigated and a Long-Endurance Conceptual Design Program (LECDP) has been developed and is presented briefly below.

## 2.1. Energy Sources

At the scale of Mini and Micro UAVs, energy storage systems become even more problematic than the bigger UAVs since it can reach 40% of the total weight. Thus, a wide research of current state of the art for energy sources has been completed. The paper contains a brief survey of this research.

Battery technology keeps improving rapidly because of the huge demand of portable computers, cell phones and Radio Control models. Currently Lithium-Polymer batteries are the most dominant ones in the market. They have a specific energy of 150 to 200  $Wh/kg$ . After scanning the whole envelope for suitable battery technology (Table 1), Lithium-Polymer and Lithium-Sulfur<sup>1</sup> batteries were selected as the two candidates for the calculations.

Most recent long-endurance world records for small UAVs, that are just using the energy stored on board, are broken with Fuel-cells[1, 2]. Fuel-cells have high specific energy around 1000  $Wh/kg$  which is a great advantage. However their minimum initial system weight is around  $1.9 kg^2$ . Although this system has sufficient energy for 10 hours of flight for a UAV that has 2.5 m wing span<sup>3</sup>, it doesn't seem to be feasible to realise a long-endurance UAV smaller than 2 m wing span utilising fuel-cells at this stage because of the total system weight. As we are dealing with a Mini-UAV whose maximum dimensions do not exceed 1 meter, we are obliged to wait and watch the new technology progress.

Benefiting from solar energy became very popular in the sense of green energy and also became feasible for small UAV activities since the solar-cell technology improved a lot. Recent Silicon solar cells are thin, flexible and very light while still having a reasonably good efficiency. These properties make them well suited for the small UAV activities. After a market search we obtained S-32 Silicon cells (Figure 1) which are the state of the art high efficiency, low weight silicon cells with an integrated by-pass diode (AzurSpace solar Power GmbH<sup>4</sup>).

There are several examples of applications about utilising solar energy in UAVs [3, 4] but recently the most remarkable one and the most closest one to Mini-UAV scale is for sure the SkySailor<sup>5</sup> [5] which has accomplished a 27 hours continuous flight. Although Noth et al.[5] resulted on 3.2 m wing span for continuous flight (between certain place and time of the year), they also showed the feasibility of a solar powered Mini-UAV which has 0.77 m wing span [6].

Table 1. Battery specifications from different sources. Numbers for Li-Po have been measured while the numbers for Li-S come from the manufacturer.

	Ni-Cd	Ni-Mh	Li-Po	Li-S
Specific Energy ( $Wh/kg$ )	40	80	180	350
Energy Density ( $Wh/l$ )	100	300	300	350
Specific Power ( $W/kg$ )	300	900	2800	600

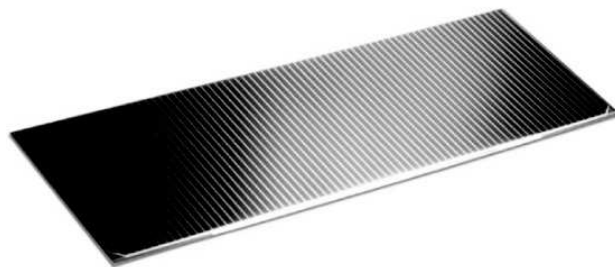

Size (mm)	32 × 74
Weight (g)	0.757
Open circuit V (mV)	628
Open circuit I ( $mA/cm^2$ )	45.8
Voltage @ Pmax (mV)	528
Current @ Pmax ( $mA/cm^2$ )	43.4
Avg. Efficiency (%)	16.9

Figure 1. Azur Space S-32 solar cell and its specifications.

<sup>1</sup>www.sionpower.com

<sup>2</sup>www.protonex.com

<sup>3</sup>www.ns.umich.edu/htdocs/releases/story.php?id=6833

<sup>4</sup>www.azurspace.com

<sup>5</sup>sky-sailor.epfl.ch

## 2.2. Extracting Energy from Environment

On-board energy storage is always limited and additional capacity always brings additional weight. That's why calculations end up with an optimum total weight that corresponds to a certain storage capacity. This limits the energy that we can carry on-board. However extracting energy from the environment not always needs an additional system weight and can be continuous for some cases which will certainly make a huge improvement in endurance performance of the UAVs [7].

A good example for extracting energy from the environment is achieved by D.J. Edwards [8]. By actively searching out and having advantage of thermals, naturally occurring convective air updrafts, and using the initial potential energy from a 140 m launch, their autonomous SBXC glider achieved 48 km of distance while staying aloft 1.5 hour.

The challenge is to design a UAV that is optimised for extracting energy from the environment, utilising different energy sources if there is more than one and being capable of managing the required mission at the same time.

This part will not take place in the design method for now since there is already a lot of challenges with utilising the energy systems alone, but planned to be explored in the following months.

## 2.3. Long Endurance Conceptual Design Program "LECDP"

The objective of LECDP is to be able to see the variation of performance values such as endurance and range for different kinds of designs, and it also aims to fix the performance values and search for a feasible geometry for conceptual design. The most important philosophy behind LECDP is to keep it as simple as possible and still be very flexible to change and adapt it for the new technological improvements. So a simple block structure in Scilab<sup>6</sup> is used for writing the program. Figure 2 simply shows the main blocks that are working together in the program.

The program runs with the identified design variables such as wing geometry, mission requirements, cruise velocity etc. All of the assumptions made in the early design are included in the input such as propeller, motor, speed controller and battery efficiencies, parasite drag coefficient for fuselage, battery and motor weight constants to find the corresponding weight for a given voltage and power. First estimation of battery weight and capacity is made in the **Battery Weight Estimation** Block.

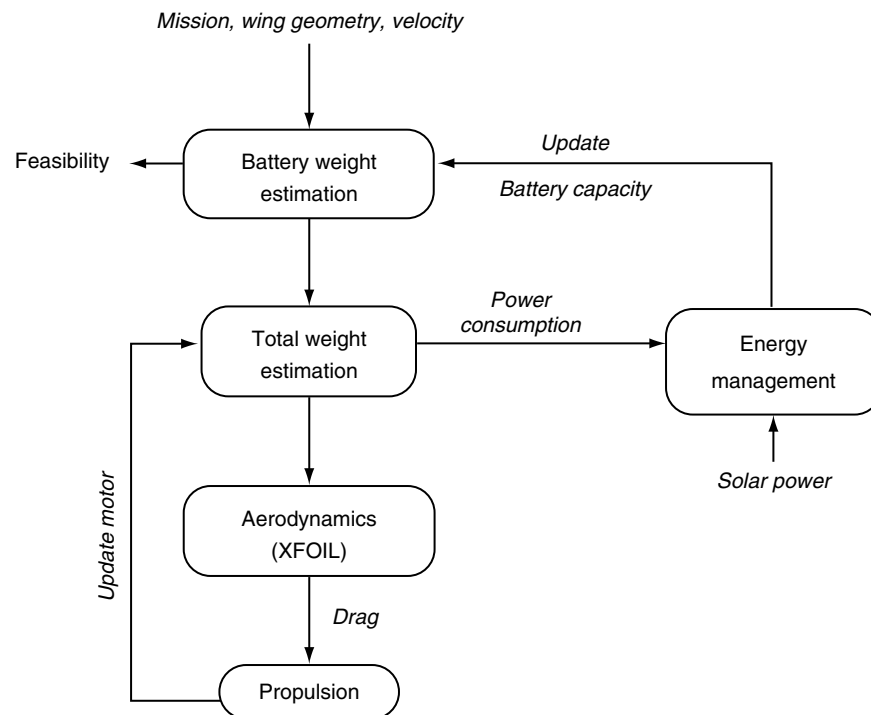

**Figure 2.** Brief Flow-Chart of the LECDP.

<sup>6</sup>www.scilab.org

All of the mass values are generated and summed in the **Total Weight Estimation** Block. Then iteration starts with updating the **Aerodynamics** Block with the new total weight, here the required lift coefficient is calculated by using the first given design variables. Traditional formulas are used to find the infinite 2-D airfoil lift coefficient then in order to have a better estimation of the drag, an external program **XFOIL**<sup>7</sup> is called[9]. This is much more convenient than having a constant value for skin friction and pressure drag coefficient of an airfoil since XFOIL also takes into account Reynolds variations, and also gives permission to change the airfoil used in the design program. After calculating the total drag of the plane, the **Propulsion** Block updates the motor weight in the **Total Weight Estimation** Block taking into account the required thrust and power until a fixed point is reached and then power consumption is calculated.

The **Energy Management** Block is responsible for utilising the existing energy source, and combining them together for an hybrid use or charging process. The **Solar Power** Block uses a sinusoidal model of the Sun Irradiation and calculates the power output and weight of the solar cells to be updated in **Energy Management** and **Total Weight Estimation** Blocks.

If a performance value is fixed, like the one which is going to be described in Section 2, then the **Battery Weight Estimation** Block will keep changing the capacity and updating the weight till the target value is reached if it is feasible otherwise program moves to the next input values.

The explained Block architecture allows the user to change the Blocks independently if needed. Of course coefficients and constants used in the early design are really important, since they can affect the performance dramatically. So as to verify the coefficients, the focus is on both theoretical and experimental studies.

## 2.4. Paparazzi Autopilot

There are several world records and record attempts in F5S FAI class<sup>8</sup> on which the pilots are in the loop all the time and flying the aircraft manually around 12 hours<sup>9</sup>. One of the main objective of this study is to have the aircraft flying autonomously without requiring a human pilot for stabilisation and navigation.

Paparazzi is an open-source autopilot system oriented toward inexpensive autonomous aircraft of all types. The project began in 2003 and has enjoyed constant growth and evolution ever since. The system has been used on dozens of airframes and implemented by several teams around the world. Hundreds of hours of autonomous flight have been successfully achieved with the Paparazzi system.

The Paparazzi system (Figure 3) is extensively described in [10, 11] and cooperatively documented in a the [paparazzi.enac.fr](http://paparazzi.enac.fr) wiki.

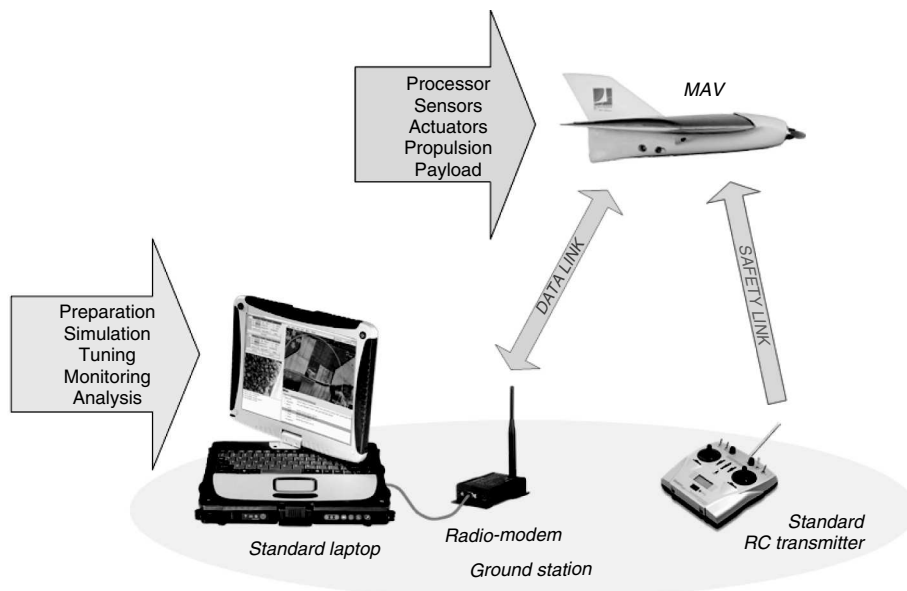

**Figure 3.** The Paparazzi system includes the airborne autopilot and the GCS.

<sup>7</sup>[raphael.mit.edu/xfoil/](http://raphael.mit.edu/xfoil/)

<sup>8</sup>[www.fai.org](http://www.fai.org)

<sup>9</sup>Oklahoma State University DragonFly Project, [osu.okstate.edu](http://osu.okstate.edu)

There are of course several pros and cons of using an autopilot versus a human pilot. A human pilot has hidden expertise, can examine the environment efficiently and take advantage of it immediately (like topology-wind interaction for slope flight, thermalling birds, dust devils).

However having an autopilot on-board ensures the ability to fly out of sight, and a much better stability of the aircraft even in a perturbed environment by the help of the on-board sensors. It is also able to control and fly at the exact attitude which is needed most of the time in order to get the best flight performance of the aircraft and to keep better track of the navigation for an efficient surveillance mission. The most important advantage is to control the propulsion system much more efficiently for a longer energy run. Having Paparazzi Autopilot on-board will sustain these benefits to achieve long-endurance flights with a mini-UAV.

### 3. CORSICA MISSION

#### 3.1. Mission Description

The Corsica Mission was just an idea that came out of a brainstorming session at first and later was started by two groups of students from ISAE ([www.isae.fr](http://www.isae.fr)) and ENAC ([www.enac.fr](http://www.enac.fr)) also with the contributions of the two Institute's advisors. It was a short term project that was to be fulfilled in 9 months. The main objective of the project is to design and build the smallest possible electric powered UAV that will have a capability to survey a 200 km line autonomously. To prove the feasibility of the project, the mission was chosen to be performed over the Mediterranean Sea across Nice and Calvi (Corsica), which also brings the originality of the project (Figure 4).

#### 3.2. Relevance of the Mission with Long Endurance

Although the project is not totally concentrated on the Long-Endurance objective, still 200 km of range requires a long-endurance capability for such a small electric UAV. So the project is a good candidate for the LECDP to be tested. Additionally, the flight test results gave us the opportunity to compare and verify the initial coefficients which have been chosen in the beginning.

#### 3.3. Prototype Design and Manufacture

As we have been trying to push the limits to extremes, we couldn't select the regular values for any of our coefficients and constraints such as wingloading, power to weight ratio, emptyweight fraction, etc.

In order to verify our first assumptions and coefficients we decided to build a prototype rapidly. First of all, we were in search for a suitable and meaningful cruise speed for the mission. As it is a kind of surveillance mission, it is decided that the cruise speed should not go higher than a certain value. The lower boundary of the speed envelope has no limitation because the stall speed of the designed aircraft will already limit it. After several analysis with LECDP, 20 m/s cruise speed was chosen to be appropriate for the mission taking into account for both the energy consumption not to be too high and the mission time not to be too long to be risky for the effect of cross-wind. The required battery capacity values for a span variation from 1 m to 1.8 m for 20 m/s cruise speed is presented in Figure 5. Here it can be seen that for an UAV with 1.8 m span and 0.2 m<sup>2</sup> wing area, 19 Ah of battery capacity (at 14.8 V) is needed

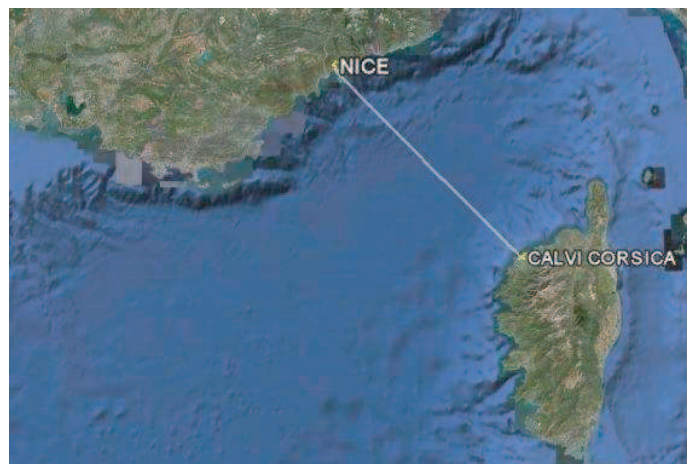

**Figure 4.** Planned Corsica mission flight path (200 km).

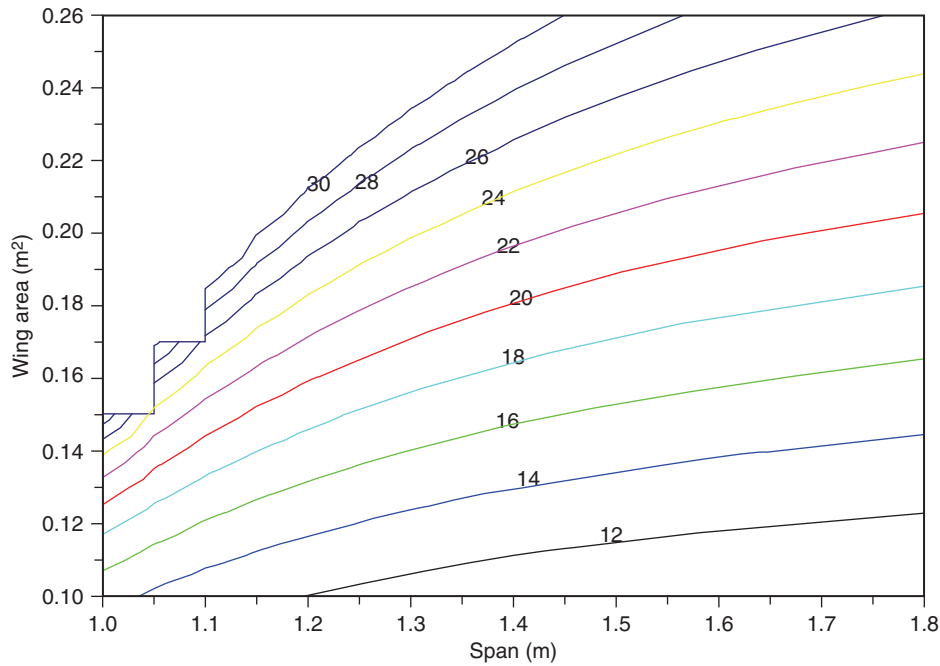

**Figure 5.** Required battery capacity in Ah for 20 *m/s* cruise speed (14.8 V, 200 km).

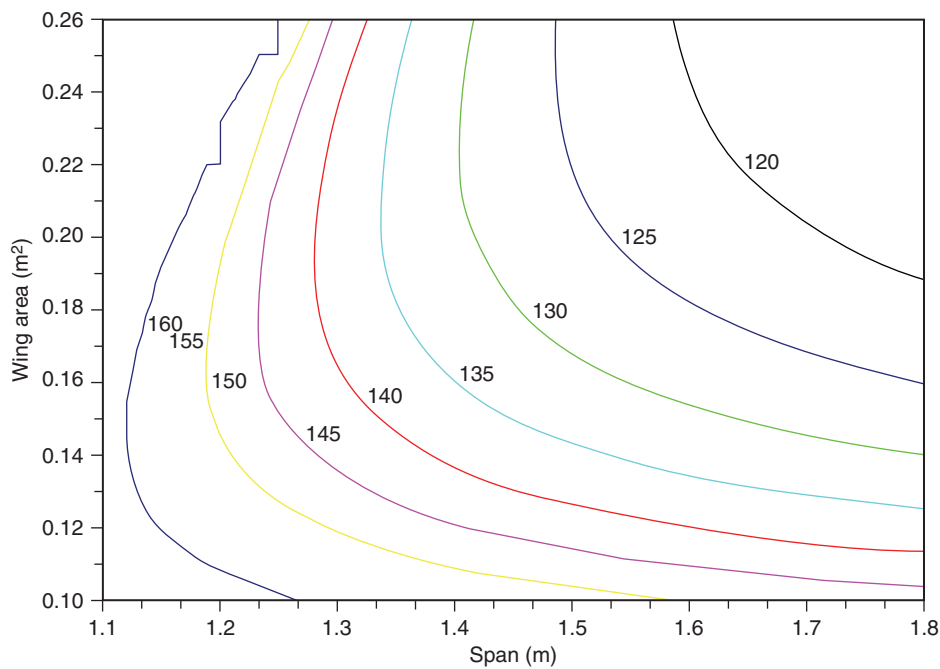
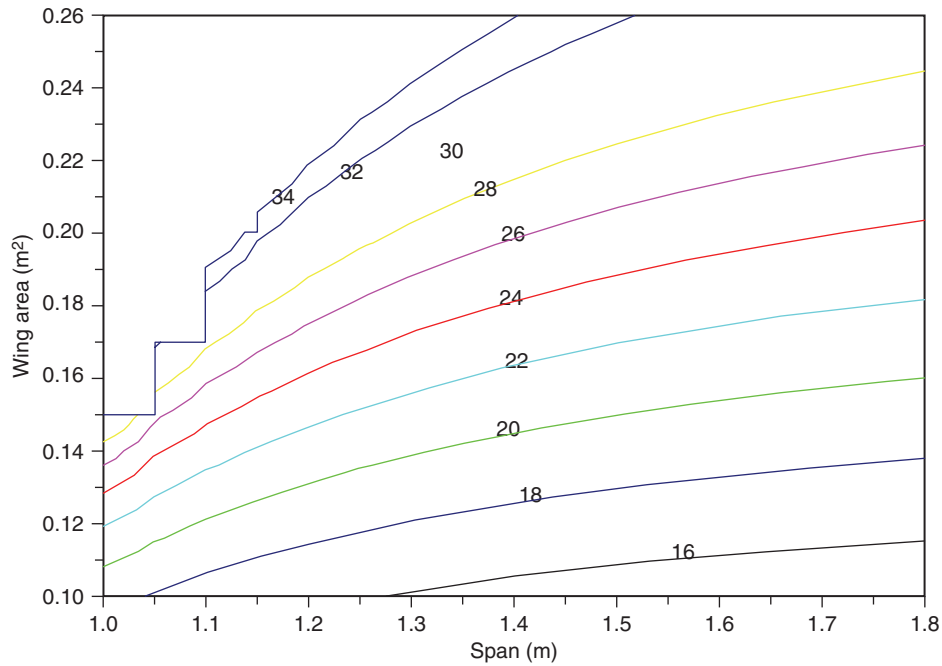

**Figure 6.** Wing-loading ( $N/m^2$ ) at 20 *m/s* cruise speed for a 200 km mission.

to cover 200 km of straight line where as for a 1.2 m span and the same wing area of 0.2  $m^2$  the required battery capacity becomes 28 Ah.

After the choice of cruise speed, LECDP analyses were examined again to see the variation of wing-loading and total weight for different wing spans and areas (Figure 6 and 7). As the objective is to be as small as possible, it is favourable to stay in the lower left end of the graphs but, as it is seen in Figure 6, the wing-loading value is getting too high compared to an radio-controlled electric model's wing-loading which is around 20 – 60  $N/m^2$ . Also as LECDP does not take construction and component





**Figure 7.** Total weight ( $N$ ) at  $20\text{ m/s}$  cruise speed for a  $200\text{ km}$  mission.

Table 2. Chosen values for the  $200\text{ km}$  mission prototype from the LECDP results.

Required Total Power	( $W$ )	126.44
Battery Capacity	( $Ah$ )	25.94
Structural Weight	( $N$ )	5.35
Total Weight	( $N$ )	29.45
Wing-Loading	( $N/m^2$ )	124.28
Lift Coefficient		0.5072
Span	( $m$ )	1.5
Chord	( $m$ )	0.158
Drag	( $N$ )	2.36

storage problems into account, a final decision of the human expert is needed. As an example, the batteries are decided to be placed all in the wing, which creates a constraint between the volume of the total batteries and the volume of the wing. And as the battery volumes are fixed with the shape, after some market search and analyses, chord of the wing is fixed according to the selected battery type. This makes it possible to represent the wing span by the number of batteries inside or by the capacity as well. While keeping the wing-loading in a safe region and optimising the wing span, corresponding battery capacity for  $1.5\text{ m}$  wing span ended with a little bit less than needed, but the difference was small enough to compensate it with a small battery pack in the fuselage.

The fuselage is constructed from aramid besides the small reinforcement parts around motor and wing mount which are made of carbon fiber. The wings are precisely cut by a CNC foam cutter machine in Composite Laboratory of ISAE and covered with aramid and carbon fiber. As the first prototype is designed for coefficient verification and proof of concept, it doesn't have the originally selected batteries (KOKAM  $7.5\text{ Ah}$ ) instead it has three housings for inserting steel rods to simulate the battery weight and inertia in the wing. This also allows us to progressively increase the weight of the Prototype to measure its flying characteristics and also power consumption for different weights.

### 3.4. Propulsion and Flight Tests

The prototype's wing design permits the testing of different weights. First to measure the flight characteristics of the plane, only carbon rods are inserted for joining the two wing-halves and as a result the first flights were made for only  $1\text{ kg}$  of total mass. At this weight, it was satisfactory enough to

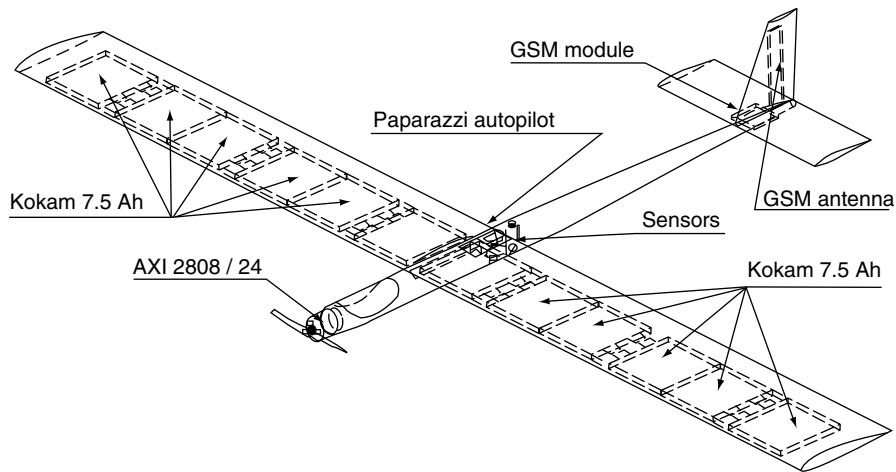

**Figure 8.** Sketch of the prototype for the 200 km mission.

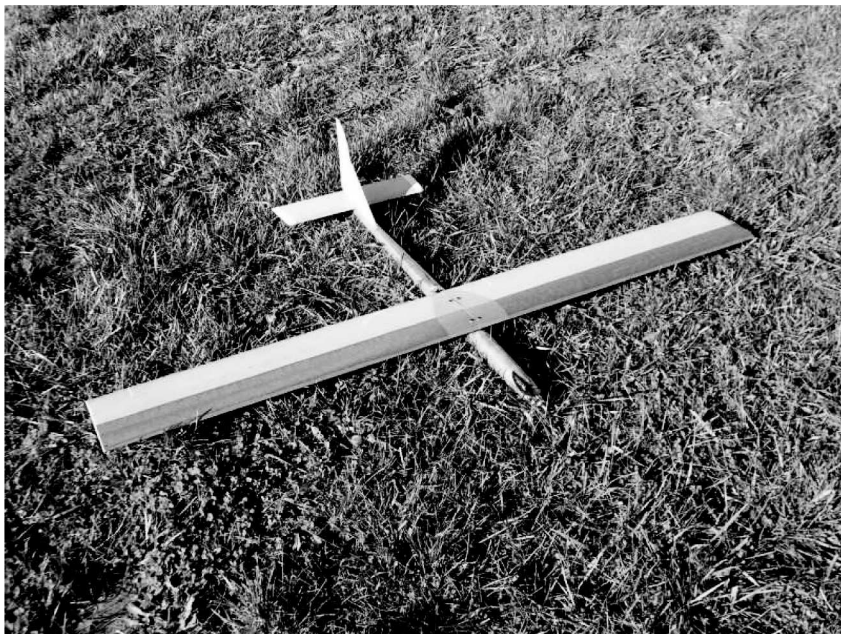

**Figure 9.** The 200 km mission prototype ready for its first flight.

hand-launch the plane. After tuning the manual and autopilot settings, steel rods were inserted for progressively increasing the weight up to expected flying weight.

In order to obtain aerodynamic and propulsion efficiencies from the flight tests, two methods were planned. The first was to climb to a safe altitude, glide along a straight line without throttle at a certain velocity to obtain the lift to drag ratio of the whole plane [12, 13]. Lacking of a differential pressure sensor for speed measurements and just relying on GPS information for speed and altitude, environmental effects such as thermals and sinks, made it not possible to have satisfactory results in short term glide tests. So a long term test was decided upon, in which values were averaged in order to give better values. In Figure 11, which is the view of the flight test trajectories exported to Google Earth, fixed altitude circle and oval type flights can be seen. On those flights, altitude and cruise speed were kept as constant as possible and circles were flown for 160 seconds autonomously. The power consumption was also recorded. After averaging, it is seen that the cruise speed is 18.6 m/s instead of 20 m/s, which also affects the predicted design power consumption. Table 3 shows the previously designed values, the values obtained from flight tests and the updated values as the cruise speed

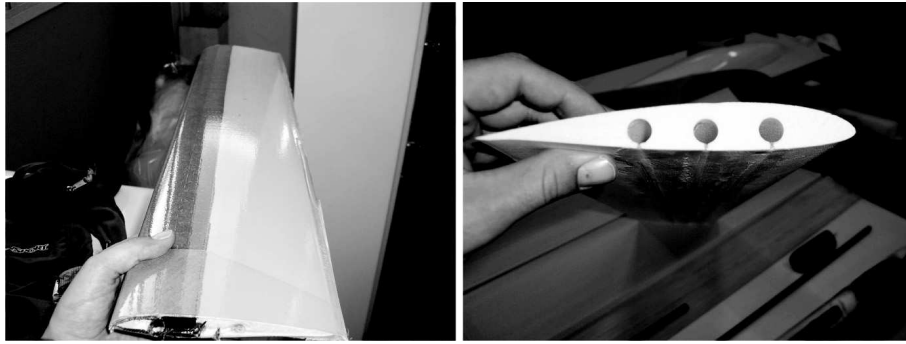

**Figure 10.** Surface quality and holes for steel rods simulating battery weight and inertia.

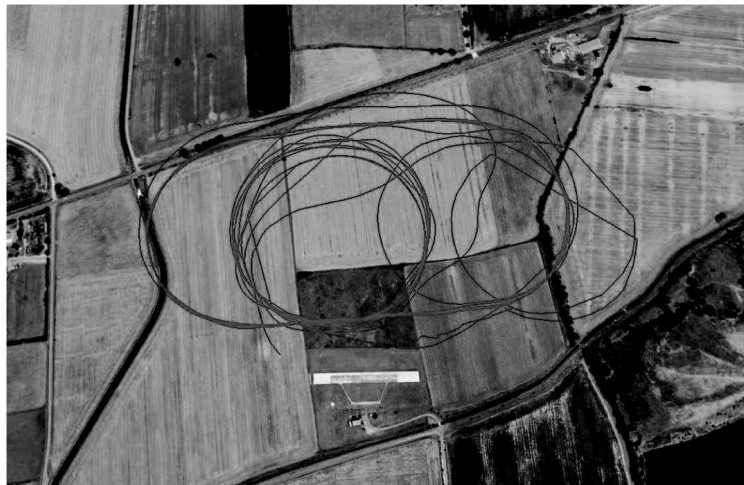

**Figure 11.** First autonomous flight test of the 200 km mission prototype.

Table 3. Variation of Designed, Tested and Updated values.

		Designed	Flight	Updated
Total Power	( $W$ )	126.44	63.5	100.8
Cruise Speed	( $m/s$ )	20	18.6	18.6

changed between the designed conditions and the flight conditions. It can be easily seen that the first coefficient assumptions were overly pessimistic.

After modifying the coefficients according to the obtained results from flight tests, it was obvious that the size of the plane can be decreased a little bit, but unfortunately the selected batteries can only allow a major difference as the pack sizes are fixed. However another option could be to change the battery type and brand but as it is a short term project, there was not enough time to do that.

#### 4. STUDY FOR A HYBRID SOLAR POWERED MAV

Although having verified the coefficients with the flight test of the prototype, the results that were obtained from LECDP for MAVs were not consistent. So we used previous flight data acquired from Slicer and Storm-1<sup>10</sup> and wind-tunnel results to recalibrate some of the coefficients in the LECDP for MAV scale. After this tuning, analyses were done for the hybrid system with the solar energy and Li-Po battery taken into account. The objective was to see the feasibility of using solar energy for MAVs to enhance the flight time.

Two different configuration were taken into account, 500 mm and 300 mm span. For each of the configurations, wing area and endurance have been optimised using LECDP for a given battery capacity on board (910 mAh).

<sup>10</sup>Previous MAVs that were designed and flew in competitions by our team

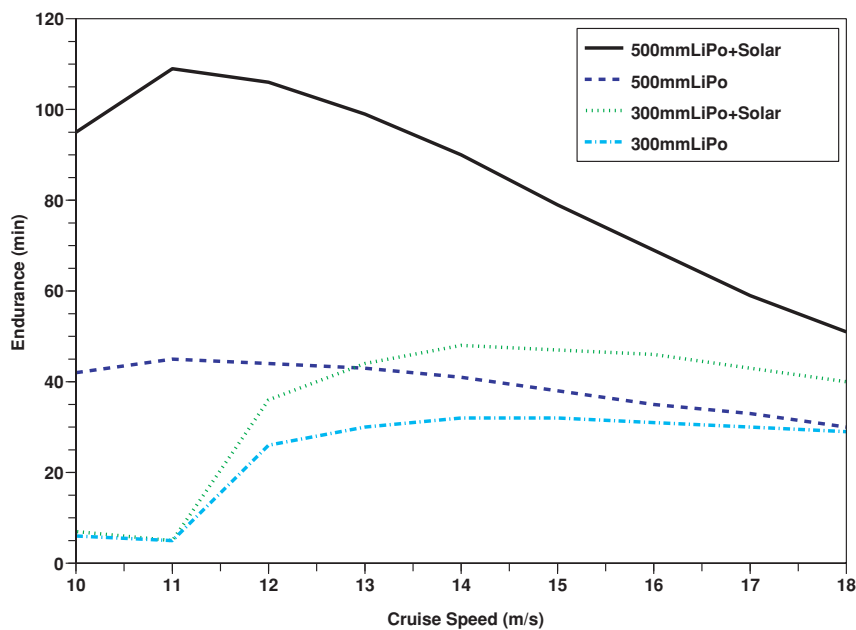

**Figure 12.** Endurance comparison of 500 mm and 300 mm MAVs using solar cells.

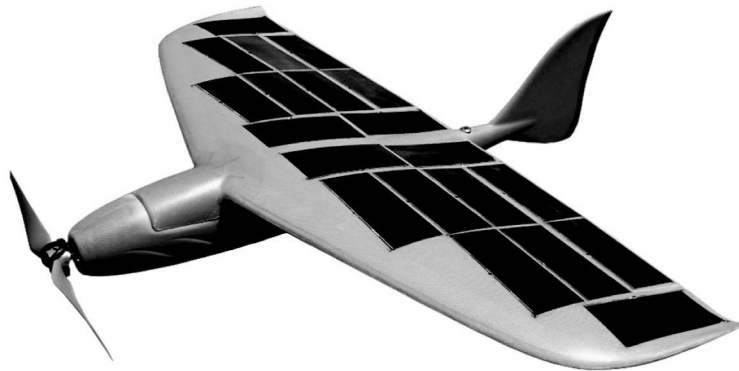

**Figure 13.** The 500 mm Solar-Storm prototype covered with 20 S-32 solar tiles.

In the analyses, the maximum sun irradiance is taken as  $900 \text{ W/m}^2$  and 70% of the wing is assumed to be covered with solar cells. The efficiency of the solar cells, 16.9%, is taken as it is given in the data sheet of the manufacturer.

Figure 12 shows the flight time versus the cruise speed of two different configurations with and without solar cells. Both have the same battery capacity on board. It can be seen that the benefit that is taken from solar cells for flight time is much higher for the bigger 500 mm MAV than the small 300 mm one. It can be shown that under a certain size, there is almost no benefit that can be taken from the solar cells. This is a result of the reduced wing surface area of the small sized MAV reducing the total solar cell area which is linearly proportional with energy extracted from the sun. Another important issue is the weight ratio of the solar cells and the required electronics to the weight of the MAV. This ratio is becoming larger when the MAV gets smaller in size, reducing the overall efficiency of the MAV. It should be noted that these conclusions are made taking into account the Paparazzi autopilot and electronics weights.

Figure 13 shows the hybrid solar powered MAV prototype. Twenty RWE Si-32 solar cells are bonded on the wing with silicon based glue<sup>11</sup>. The wing platform is optimised in order to place the

<sup>11</sup>With the collaboration of the [www.map-coatings.com/company](http://www.map-coatings.com/company)

maximum number of solar cells safely on the surface while keeping in mind the span efficiency, elliptical loading and the tip stall issues. This was especially important in order to reach the same percentage of solar cell area to wing area that we have assumed in the calculations.

The powerful XFOIL airfoil analysis and design program is used to design the airfoils. There are three different custom airfoils along the span, which are particularly designed according to their corresponding Reynolds number for the cruise speed while observing the stall behaviour and maximum lift coefficient. Spanwise transition and the design procedure will not be included here more deeply as it is not in the scope of this paper.

#### 4.1. Maximum Power Point Tracker

Although we have kept the efficiency of the solar cells constant and at maximum value (16.9%) in the calculations, this is not exactly true for all cases in real life. According to the angle of the solar cells with the sun rays, time of the day and year, geographic location, solar cells will have different output power.

When the pads of the solar cells are not connected, the voltage between the pads is  $V_{OC}$  the open circuit voltage and the current is null. When the pads are short circuited, the voltage becomes zero and the current is  $I_{SC}$ , the *short circuit current*. The maximum output power has to be found between these two points. This point is called maximum power point (*MPP*) and the voltage and the current at this particular point are  $V_{MPP}$  and  $I_{MPP}$ .

The search for the *MPP* requires an ad hoc electronics circuitry adapted in real time with a control loop. Figure 14 shows the schematics of this board. Note that it includes a micro-controller which can be linked to the autopilot to be monitored from the ground station.

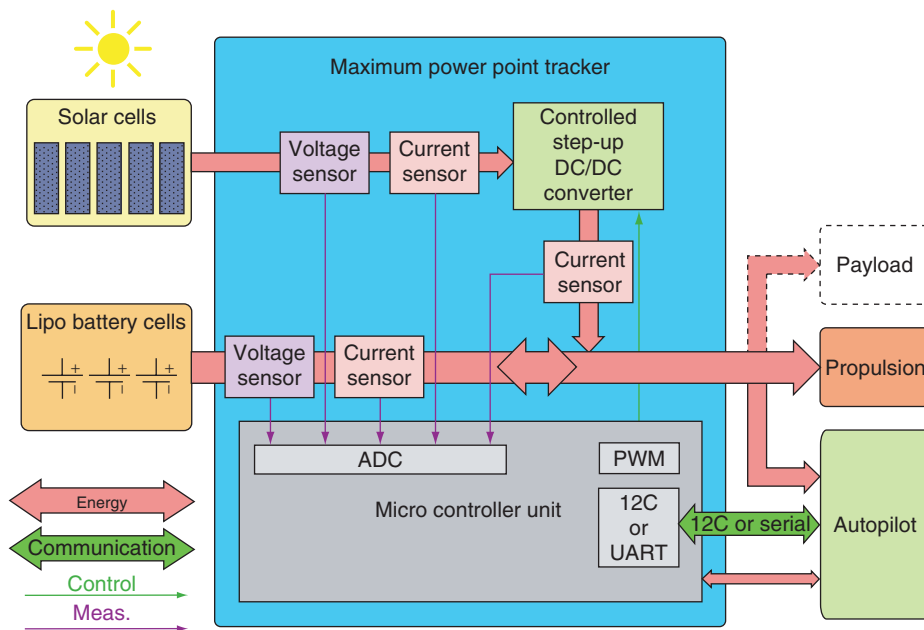
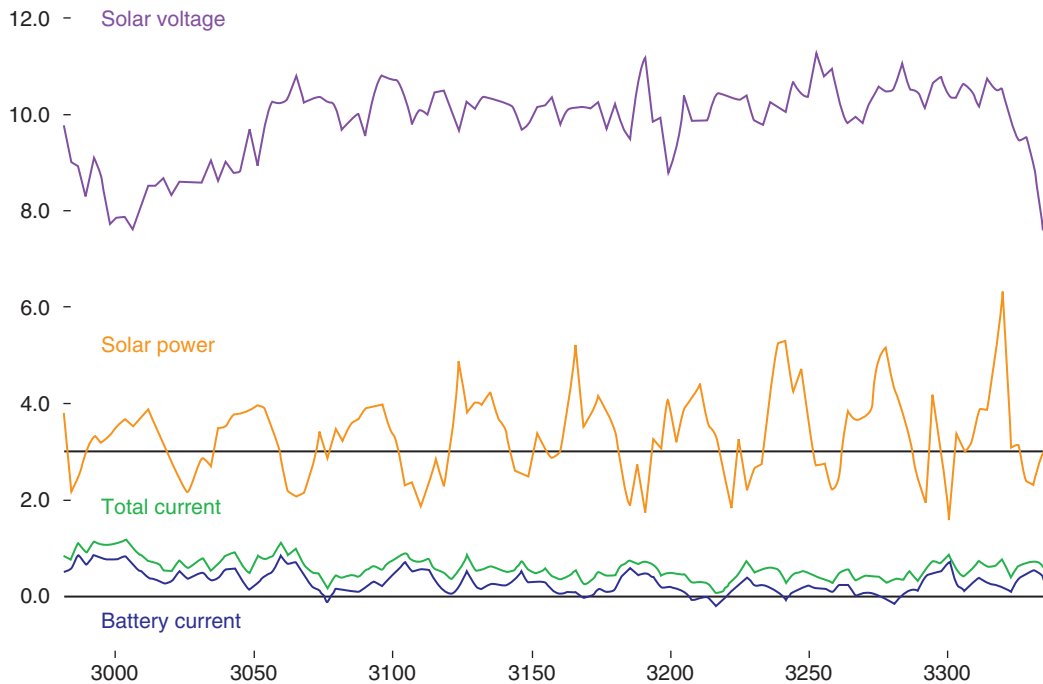

**Figure 14.** Maximum Power Point Tracker (MPPT) to optimize solar cells usage.

#### 4.2. Initial Flight Test Results

The second flight test with the Solar-Storm has resulted with an endurance of 90 minutes. Figure 15 displays the power management for a five minutes part of the flight. The variation of solar voltage can be seen between 7 V and 11 V due to clouds shadows.

The sinusoidal behaviour of the obtained solar power can be easily seen. This is due to the circular flight path: As the plane banks to the direction of where the solar rays comes, the solar power increases and when it banks to the other direction, the solar power decreases. As an average, 40% of the total power is obtained from the solar cells during the flight.



**Figure 15.** Solar Voltage (*Volt*), Solar Power (*W*), Total (solar+battery) and Battery Current (*A*) during 300s of flight. When the battery current is non positive, the battery is charged.

Attention should be pointed to the short periods where the Battery Current goes below zero, meaning that the on board battery is charged, an unexpected great achievement for such a small sized solar MAV.

## 5. CANDIDATE DESIGN FOR EMAV09 ENDURANCE MISSION

### 5.1. Mission Definition

The EMAV09 Outdoor Endurance Mission simulates a payload drop task where the target is far away from the launch zone. The distance between the launch zone and the target is simulated by flying a number of laps to the target, dropping a paintball on the target and then returning by flying the same number of laps before landing.

Although it has been shown in the previous sections results that a 300 mm MAV will not be able to achieve flight times as long as a 500 mm MAV does, still the rules of EMAV09 Endurance Mission promote being small by taking into account maximum dimension at the flight score calculation.

However, the mission is more focused on the range performance rather than the maximum airborne time. So, it is more important to fly at the “maximum lift to drag ratio speed” of the MAV rather than the “minimum power consumption speed” in order to get more points.

### 5.2. Computation Results

We have compared three candidates for the mission: the 300 mm Slicer, the solar powered 500 mm Solar-Storm and the 500 mm Fire-Storm. The Fire-Storm (Figure 16) has the same airframe as the Solar-Storm and is filled with as much battery capacity as possible. In order to stay in the optimum point of the designed airfoils while keeping an operable flight speed, it is powered with two 1320 mAh batteries (3 cells).

We compare here the expected scores for the three aircraft for different wind speeds. We make the hypothesis that, flying ovals, the average ground speed is  $(V^2 - W^2)/V$  where  $V$  is the airspeed and  $W$  the wind speed. The oval lap length is estimated to 1150 m.

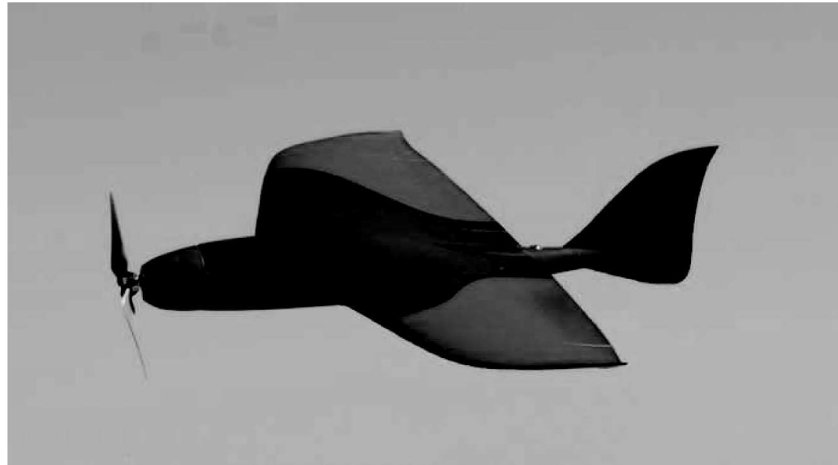

**Figure 16.** The 500 mm Fire-Storm designed for the EMAV09 Endurance mission.

Table 4 gives the number of laps and the corresponding expected score (autonomy set to 9, size  $S$  in mm, endurance  $T$  in min):

Table 4. Scoring and lap numbers for the EMAV09 endurance mission for different wind speeds (0, 5 and 10 m/s).

	$S$ (mm)	$V$ (m/s)	$T$ (min)	$W = 0$	$W = 5$	$W = 10$
Slicer	300	12	35	22/388	18/317	6/105
Solar-Storm	500	12	145	<b>90/910</b>	<b>74/666</b>	26/234
Fire-Storm	500	16	90	74/666	68/612	<b>46/414</b>

The hypothesis for the Solar-Storm are highly optimistic: optimum hour in the day and sun irradiance about  $900 \text{ W/m}^2$ , something which probably never happen in Holland in September. So from these numbers and expected weather, the Fire-Storm seems more favourable.

## CONCLUSION

The so called LECDP (Long Endurance Conceptual Design Program) has been presented with the methodology behind it. A real mission has been described and design phase of the prototype for the mission is presented. Also the comparison of the calculated power consumption and the power consumption obtained from flight tests has been done. The results obtained from those comparisons are used for coefficient verification and calibration. Similar procedure is followed to calibrate the coefficients for MAV scale. Obtained results have been shown for possible long endurance MAVs utilising a hybrid solar energy and Lithium batteries. It is seen that there is a minimum size limit for the MAV to be able to use solar energy and below that limit it is no use to have solar cells and the required electronics on board for enhancing the flight time. In the last section, an initial study has been made to achieve a high score for the EMAV09 Outdoor Endurance mission. Future work will include updating the LECDP in the light of all obtained results, and implementing a more precise modelling of the aircraft.

## ACKNOWLEDGEMENTS

The present research has been partially supported by ENAC and ISAE under the aegis of the University of Toulouse. The authors would like to express their gratitude to Guy Mirabel and Xavier Foulquier from the composite laboratory of ISAE for their help to the fabrication of prototypes, M. Etienne Rapp from CNES for his advice regarding solar cell technology, M. Olivier Guillaumon and M. Yann Ollivier from the MAP coatings company for their helpful advice on solar cells bonding.

**REFERENCES**

- [1] Thomas H. Bradley, Blake A. Moffitt, Dimitri N. Mavris, and David E. Parekh. Development and experimental characterization of a fuel cell powered aircraft. *Journal of Power Sources*, 2007.
- [2] Thomas H. Bradley, Blake A. Moffitt, Thomas F. Fuller, Dimitri Mavris, and David E. Parekh. Design studies for hydrogen fuel cell powered unmanned aerial vehicles. In *American Institute of Aeronautics and Astronautics*, Honolulu, Hawaii, August 2008.
- [3] Alan Cocconi. Solong UAV : Solar electric powered. Technical report, AC Propulsion, CA, 2005.
- [4] André Noth. History of solar flight. Technical report, Autonomous Systems Lab, Zürich, 2008.
- [5] A. Noth. *Design of Solar Powered Airplanes for Continuous Flight*. PhD thesis, ETH ZÜRICH, 2008.
- [6] N. Diepeveen. The sun surfer: Design and construction of a solar powered MAV. Master's thesis, Autonomous Systems Lab, ETHZ, Zürich, March 2007.
- [7] Ying Celia Qi and Yiyuan J. Zhao. Energy-efficient trajectories of unmanned aerial vehicles flying through thermals. *Journal of Aerospace Engineering*, April 2005.
- [8] D. J. Edwards. Implementation details and flight test results of an autonomous soaring controller. In *American Institute of Aeronautics and Astronautics*, 2008.
- [9] Harold Youngren Mark Drela. *XFOIL 6.94 User Guide*. MIT Aero and Astro, 2001.
- [10] P. Brisset and A. Drouin. PaparaDzIY: do-it-yourself UAV. In *Journées Micro Drones*, Toulouse, France, September 2004.
- [11] P. Brisset, A. Drouin, M. Gorraz, P.-S. Huard, and J. Tyler. The Paparazzi solution. In *MAV2006*, Sandestin, Florida, November 2006.
- [12] Helmut Reichman. *Cross-Country Soaring*. Soaring Society of America, Inc., 2005.
- [13] Dan Edwards. Performance testing of RNR's SBXC using a piccolo autopilot. Technical report, North Carolina State University, 2008.