



HAL
open science

Analysis of L5/E5 acquisition, tracking and data demodulation thresholds

Frédéric Bastide, Olivier Julien, Christophe Macabiau, Benoit Roturier

► **To cite this version:**

Frédéric Bastide, Olivier Julien, Christophe Macabiau, Benoit Roturier. Analysis of L5/E5 acquisition, tracking and data demodulation thresholds. ION GPS 2002, 15th International Technical Meeting of the Satellite Division of The Institute of Navigation, Sep 2002, Portland, United States. pp 2196 - 2207. hal-01021712

HAL Id: hal-01021712

<https://enac.hal.science/hal-01021712>

Submitted on 30 Oct 2014

HAL is a multi-disciplinary open access archive for the deposit and dissemination of scientific research documents, whether they are published or not. The documents may come from teaching and research institutions in France or abroad, or from public or private research centers.

L'archive ouverte pluridisciplinaire **HAL**, est destinée au dépôt et à la diffusion de documents scientifiques de niveau recherche, publiés ou non, émanant des établissements d'enseignement et de recherche français ou étrangers, des laboratoires publics ou privés.

ANALYSIS OF L5/E5 ACQUISITION, TRACKING AND DATA DEMODULATION THRESHOLDS

Frédéric BASTIDE, *ENAC/TeSA*
Olivier JULIEN, *University of Calgary*
Christophe MACABIAU, *ENAC*
Benoit ROTURIER, *STNA*

BIOGRAPHY

Frederic Bastide graduated in July 2001 as an electronics engineer from the Ecole Nationale de l'Aviation Civile (ENAC) in Toulouse, France. He is now a Ph D student at the satellite navigation lab of the ENAC. His researches focus on combined GPS/Galileo receiver and study of degraded modes.

Olivier JULIEN graduated as an electrical engineer in 2001 from ENAC (Ecole Nationale de l'Aviation Civile) in Toulouse, France. He is now a Ph.D. student at the Department of Geomatics Engineering of the University of Calgary, Canada, where he is involved in the Satellite-Based Positioning and Navigation Group.

Christophe Macabiau graduated as an electronics engineer in 1992 from the ENAC (Ecole Nationale de l'Aviation Civile) in Toulouse, France. Since 1994, he has been working on the application of satellite navigation techniques to civil aviation. He received his Ph.D. in 1997 and has been in charge of the signal processing lab of the ENAC since 2000.

B. Roturier graduated as a CNS systems engineer from Ecole Nationale de l'Aviation Civile (ENAC), Toulouse in 1985 and obtained a PhD in Electronics from Institut National Polytechnique de Toulouse in 1995. He was successively in charge of Instrument Landing Systems at DGAC/STNA (Service Technique de la Navigation Aérienne), then of research activities on CNS systems at ENAC. He is now head of GNSS Navigation subdivision at STNA and is involved in the development of civil aviation applications based on GPS/ABAS, EGNOS and Galileo.

ABSTRACT

The combined use of proposed GALILEO signals and current and also future GPS signals will help users to greatly improve positioning accuracy, continuity of service, availability and integrity. The performance

brought by all these signals is degraded by the same perturbations such as multipath, effects of ionosphere or jamming. However, differences in signal designs and environments imply differences in protection against these perturbations. One type of critical criterion is the set of the key operations thresholds in receivers such as acquisition, tracking and data demodulation.

The aim of the submitted paper is to propose required signal power to noise spectral density ratio to perform acquisition, tracking and data demodulation given a desired performances. Some of the considered performance are acquisition false alarm, detection probabilities, mean acquisition time and bit error rate. These thresholds are computed for GPS L5 and Galileo E5a/E5b signals.

The paper starts with a brief review of studied signal relevant characteristics such as central frequency, code frequency and period, data rate and used coding and minimum received C/N_0 . After this, the second part is dedicated to the presentation of the different methods that can be used for acquisition, tracking and data demodulation thresholds computation. These thresholds take into account some degradations originating from the front end bandwidth, the tracking errors, and acquisition time. Benefits from pilot channels and data encoding are also highlighted. Obtained results enable to estimate C/N_0 margins with respect to minimal available C/N_0 for different GNSS signals.

I. INTRODUCTION

GNSS receivers have to perform several functions such as: signal acquisition, signal tracking and data demodulation. The performance of these functions can be expressed versus the signal to noise density ratio C/N_0 . The aim of this paper is to present results concerning acquisition, tracking and data demodulation thresholds on ICAO proposed new GNSS signals (GPS L5, Galileo E5a and E5b).

The use of standard receiver techniques to assess relevant thresholds for the three above functions is investigated. The results of this study may be used to assess the margin available in the budget link for interference of ARNS band systems. The complete analysis was presented in [Bastide et al., 2002] but here only main facts are indicated.

II. STUDIED SIGNALS CHARACTERISTICS

Three different signals are studied in this paper:

- GPS L5 (1176.45 MHz) with code frequency 10.23 MHz and length 10230 so a 1 ms code period. Minimum received power -154 dB W, bandwidth 24 MHz. This signal consists of a QPSK modulation with one data channel and one pilot channel both modulated with a Neuman-Hoffman code. A Forward Error Correction (FEC rate $\frac{1}{2}$, constraint length 7) convolutional code will be used to lower the BER. The data rate is 50 bps and 100 sps after coding.
- Galileo E5a (1176.45 MHz) with code frequency 10.23 MHz with length 10230 so a 1 ms code period. Minimum received power -155 dB W, bandwidth 24 MHz and also one data and one pilot channel (QPSK modulation). A FEC code will be used whose characteristics are assumed, here, to be identical (FEC rate $\frac{1}{2}$, constraint length 7). The data rate is 25 bps so 50 sps after applying the FEC code.
- Galileo E5b (1207.14 MHz). The code frequency is 10.23 MHz with length 10230 chips, minimum received power -155 dB W, bandwidth 24 MHz also one pilot channel (QPSK modulation). BER will be improved thanks to a FEC code whose characteristics are assumed to be identical to those of the GPS L5 code (FEC rate $\frac{1}{2}$). The data rate is 125 bps so 250 sps after coding. Although these characteristics are the more likely, they may change, the code rate could be 5.115 MHz and the FEC rate could be $\frac{1}{4}$.

III. ACQUISITION THRESHOLD COMPUTATION

The signal acquisition process is a two-dimensional search in time (code phase) and frequency defined from an uncertainty region. The signal detection problem is based on a hypothesis test. Hypothesis H1: the useful signal is present and H0 it is not present. The test statistic is compared to a threshold and the decision is made with a certain false alarm probability (P_{fa}) and probability of detection (P_d).

The acquisition strategy studied here is the single dwell time search [Holmes, 1990]. The uncertainty region is swept until a "hit" (output is above threshold) is found. Then the system goes to a verification phase that may include both an extended dwell time and an entry into a code tracking loop. The lost time due to a false alarm is

modelled as $K\tau_D$ sec and the single dwell time is τ_D . If a true hit is observed the search is completed and the receiver has acquired the signal.

Usually P_{fa} is a given and the corresponding threshold is computed. Then performance, P_d and mean acquisition time \bar{T} , of the detector are evaluated.

There are two separate approaches to compute the threshold. The first one assumes that in the absence of the useful signal, there is only white thermal noise whereas the second one assumes that there are minor correlation peaks or cross-correlation peaks [Van Dierendonck, 1996]. These two approaches are studied in this paper.

Moreover two different strategies can be used to implement signal detection and acquisition given considered signals have a data channel (I component) and a dataless component (Q channel):

- the first method is based on the use of the only one component I or Q.
- the second one uses both the I and the Q components so as to optimize the available useful power.

Although the second strategy requires twice more correlators at receiver level, since these correlators will anyway exist in the receiver for tracking purposes, it is interesting to consider since it yields better results due to full utilisation of available signal power. However, since the approach based on a single correlator seems to have been used in previous studies [Van Dierendonck, 1996], it is also studied here.

The acquisition scheme uses correlator output samples. One can not integrate longer than 1 ms on GPS L5 because Neuman-Hoffman codes synchronization is not yet achieved at this stage. This particularity is also considered for Galileo.

The data component (I) 1 ms inphase and quadrature samples have the following expression

$$\begin{cases} I(k) = \sqrt{\frac{C}{4}} d(k) K_f(\epsilon_\tau) \cos(\epsilon_\theta) \frac{\sin(\pi \Delta f T_p)}{\pi \Delta f T_p} + n_I(k) \\ Q(k) = \sqrt{\frac{C}{4}} d(k) K_f(\epsilon_\tau) \sin(\epsilon_\theta) \frac{\sin(\pi \Delta f T_p)}{\pi \Delta f T_p} + n_Q(k) \end{cases}$$

where

- T_p is the predetection integration time and is equal to 1 ms
- C is the total (I + Q components) signal power at the output of the receiver antenna
- K_f is the crosscorrelation between the local code and the filtered incoming code

- n_I and n_Q are centred Gaussian correlator output noises with power $\sigma_n^2 = \frac{N_0 f_p}{4}$
- ϵ_θ is the difference between phases of the local carrier and of the incoming signal carrier.
- ϵ_τ is the difference between the local code delay and the incoming code delay. It is called the code uncertainty
- Δf is the difference between the frequency of the local carrier and the incoming carrier one.

Because of the presence, in I and Q samples, of the term $\frac{\sin(\pi\Delta f T_p)}{\pi\Delta f T_p}$

that has a single-sided bandwidth of 1 kHz, the frequency search bin is selected equal to 500 Hz. It is also why, signal acquisition is a frequency search. Thus the maximum frequency error Δf is inside [-250 Hz , +250 Hz] and the maximum degradation at correlator output is of 1 dB. The selected code search rate is half a chip so that the maximum degradation at correlator output is of 2.5 dB. This figure is obtained without front-end filtering effect, it means that the received code is assumed not to be distorted by the front-end filter, in fact this degradation is counted in processing losses that will appear in the final link budget. Eventually, the total maximal power degradation due to code and frequency uncertainty is equal to 3.5 dB.

Three types of acquisition processes are considered:

- cold start acquisition: search for all code and frequency bins
- aided acquisition: search for all code bins and one frequency bin thanks to, for instance, an anemometer.
- reacquisition after a short interruption: search for only one code/frequency bin

Use of only one signal component (I or Q)

The classical structure used to detect the useful signal using only one component is the following one

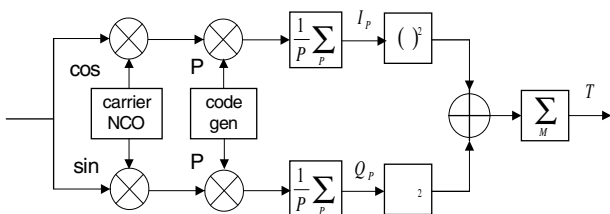

Figure 1: Standard acquisition scheme

The test statistic is $T = \sum_M (I_p^2 + Q_p^2)$. The coherent integration time is equal to 1 ms and is noted $T_p = PT_s$ where T_s is the sampling period. M is called the non coherent integration number.

Hypothesis H0: the useful signal is not present

The test statistic takes two different forms given minor cross-correlation peaks are considered or not. If there are not considered, the test statistic is

$$T_0 = \sum_{k=1}^M [n_I^2(k) + n_Q^2(k)]$$

where n_I and n_Q are defined previously. $\frac{T_0}{\sigma_n^2}$ is a χ^2

(chi square) distribution with $2M$ degrees of freedom and the false alarm probability is

$$P_{fa} = \Pr[T_0 > Th] = \int_{Th}^{\infty} p_{T_0}(y) dy = f(Th)$$

$p_{T_0}(y)$ is the probability density function of the test statistic. The threshold Th can easily be deduced by inverting function $f(Th)$ that is known. For instance, if the false alarm probability has the following classical value $P_{fa} = 10^{-3}$ then $Th = 59.7\sigma_n^2$ for $M=15$.

Now, if a minor cross-correlation peak is taken into account, the test statistic becomes

$$T_{0,J} = \sum_{k=1}^M \left[\left(\sqrt{\frac{C_J}{4}} D_J(k) K_f(\epsilon_{\tau,J}) \frac{\sin(\pi\Delta f_J T_p)}{\pi\Delta f_J T_p} \cos(\epsilon_{\theta,J}) + n_I(k) \right)^2 + \left(\sqrt{\frac{C_J}{4}} D_J(k) K_f(\epsilon_{\tau,J}) \frac{\sin(\pi\Delta f_J T_p)}{\pi\Delta f_J T_p} \sin(\epsilon_{\theta,J}) + n_Q(k) \right)^2 \right]$$

where

- C_J is the total (I+Q) power of the received GNSS signal at antenna output
- $K_f(\epsilon_{\tau,J})$ the value of the normalized crosscorrelation of the searched code and the filtered interfering code in $\epsilon_{\tau,J}$, the difference between the local code delay and the interfering code delay
- Δf_J is the difference between frequencies of variation of the local carrier phase and of the interfering carrier phase
- $\epsilon_{\theta,J}$ is the difference between phases of the local carrier and of the jamming signal

$\frac{T_{0,J}}{\sigma_n^2}$ is a noncentral χ^2 distribution with $2M$ degrees of freedom, the noncentrality parameter is

$$\lambda_J = \frac{M}{f_p} \frac{C_J}{N_0} K^2(\epsilon_{\tau,J}) \left(\frac{\sin(\pi\Delta f_J T_p)}{\pi\Delta f_J T_p} \right)^2$$

The false alarm probability is given and must be associated to a precise $\frac{C_J}{N_0} K^2(\epsilon_{\tau,J})$ that has to represent

the worst real case. Afterwards the threshold Th is easily computed, see the noise only case. [Van Dierendonck,

1999] has chosen $\frac{C_J}{N_0} K^2(\epsilon_{\tau,J}) = 19dBHz$ as the worst

L5 case and given E5a and E5b code properties are still under considerations this value is, here, also chosen for Galileo signals.

Hypothesis H1: the useful signal is present

In case of the useful signal is present and that only noise is present, the test statistic has the following expression

$$T_1 = \sum_{k=1}^M \left[\left(\sqrt{\frac{C}{4}} D(k) R_f(\epsilon_\tau) \frac{\sin(\pi\Delta f T_p)}{\pi\Delta f T_p} \cos(\epsilon_\theta) + n_I(k) \right)^2 + \left(\sqrt{\frac{C}{4}} D(k) R_f(\epsilon_\tau) \frac{\sin(\pi\Delta f T_p)}{\pi\Delta f T_p} \sin(\epsilon_\theta) + n_Q(k) \right)^2 \right]$$

The test statistic $\frac{T_1}{\sigma_n^2}$ is a noncentral χ^2 distribution with

$2M$ degrees of freedom, the noncentrality parameter is

$$\lambda = \frac{M}{f_p} \frac{C}{N_0} R_f^2(\epsilon_\tau) \left(\frac{\sin(\pi\Delta f T_p)}{\pi\Delta f T_p} \right)^2$$

The probability of detection is then $\Pr[T_1 > Th] = P_d$ depending on the total (I+Q) C/N_0 at the antenna output through λ .

Next figure illustrates this probability for $Pfa=1e^{-3}$, $T_p=1$ ms, $M=15, 40$ and 60 . Furthermore no uncertainty (ϵ_τ and Δf) and no front end filtering effects are taken into account.

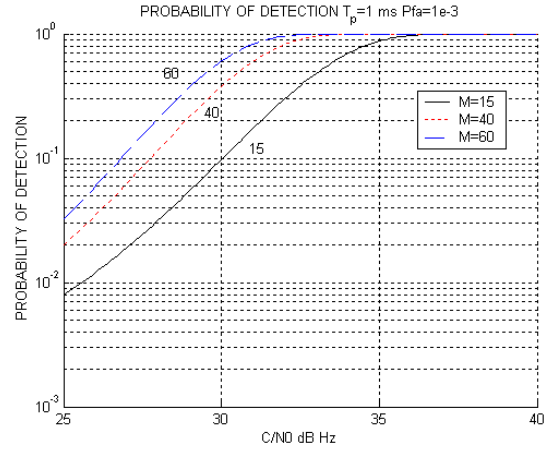

Figure 2: Probability of detection versus total (I+Q) C/N_0 at the antenna output using only one component I or Q for 1 ms coherent integration time with the first approach, without uncertainty and front end filtering effects

If one assumes that there is a minor cross-correlation peak and that the expected signal is present, the criterion $\frac{T_1}{\sigma_n^2}$ is

a noncentral χ^2 distribution with $2M$ degrees of freedom, the expected value of the noncentrality parameter is

$$\lambda = \frac{M}{f_p} \frac{C}{N_0} R_f^2(\epsilon_\tau) \left(\frac{\sin(\pi\Delta f T_p)}{\pi\Delta f T_p} \right)^2 + \frac{M}{f_p} \frac{C_J}{N_0} K_f^2(\epsilon_{\tau,J}) \left(\frac{\sin(\pi\Delta f_J T_p)}{\pi\Delta f_J T_p} \right)^2$$

Next figure shows the probability of detection for $Pfa=1e^{-3}$, $T_p=1$ ms, $M=15, 40$ and 60 . Moreover no uncertainty (ϵ_τ and Δf) and no front end filtering effects are taken into account. Again we

choose $\frac{C_J}{N_0} K^2(\epsilon_{\tau,J}) = 19dBHz$.

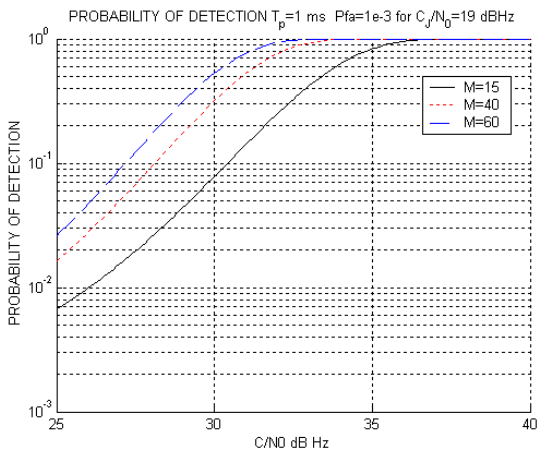

Figure 3: Probability of detection versus total (I+Q) C/N₀ at the antenna output, using only one component I or Q, for 1 ms coherent integration time with the second approach. No uncertainty and no front end filtering effects are assumed

There is little difference in the two approaches with respect to the required C/N₀ to achieve a given probability of detection.

Mean acquisition time computation

[Holmes, 1990] indicates the single dwell time search process mean acquisition time

$$\bar{T} = \frac{2 + (2 - P_d)(q - 1)(1 + KP_{fa})}{2P_d} \tau_d$$

where

- P_d is the probability of detection
- P_{fa} is the false alarm probability, here $1e^{-3}$
- q is the uncertainty region size
- τ_d is the dwell time equal to MT_p
- K is the penalty factor chosen, here, so that $K\tau_d = 1$ s. It corresponds to the time lost if a false alarm occurs

The total number of code bins to search is $10230 \cdot 2 = 20460$, when a half-chip rate is used, and there are $2 \cdot 9000 / 500 = 36$ frequency cells if a 500 Hz search rate is used; the Doppler range is $+9/-9$ kHz. Finally, the total uncertainty region size is $20460 \cdot 36 = 736560$ cells, this size is used in case of receiver cold start. If Galileo E5b uses a FEC $1/4$ code, the uncertainty region size is doubled because there are twice frequency bins due to a narrower predetection bandwidth.

If we take a look at the aided acquisition, the uncertainty region size is 20460 cells.

Figure 4 shows the single dwell search process mean acquisition time versus total (I+Q) C/N₀ at antenna output

for $P_{fa} = 1e-3$, 1 ms coherent integration time and without front end filtering effects. The plot for $M=15$ corresponds to the choice made in [Van Dierendonck, 1999] for GPS L5.

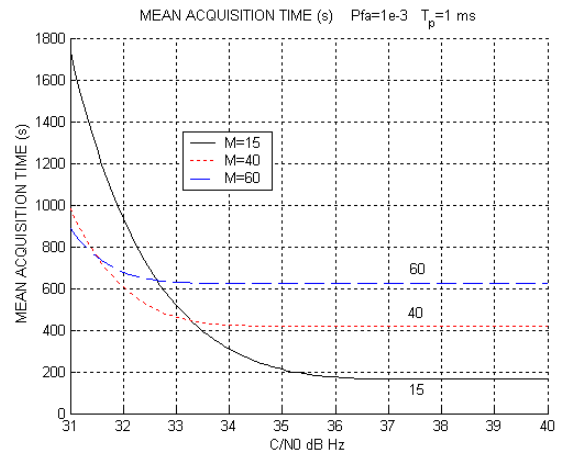

Figure 4: Single dwell search mean acquisition time versus total (I+Q) C/N₀ at antenna output using only one component I or Q for $P_{fa} = 1e-3$, 1 ms coherent integration time and when searching only one doppler bin and without front end filtering effects

It is interesting to note that for $C/N_0 = 33.7$ dB HZ, which has been retained up to now as a reference value in budget link to assess interference impact, the mean acquisition time (for 20 460 cells investigation) would be close to 350 s, for the single channel (I or Q), dual correlator structure considered in this section. As further discussed, the use of a dual (I and Q) receiver would allow to reduce simultaneously the reference acquisition threshold value and time. The presence within the receiver of more correlators would also have the same effect. Note that for 15 non coherent integrations and 1 ms coherent integration time, the asymptotic mean acquisition time is again 163.68 s.

Use of both I and Q signal components

The proposed L5 (but also valid for Galileo E5a and E5b) acquisition test is computed using the following structure:

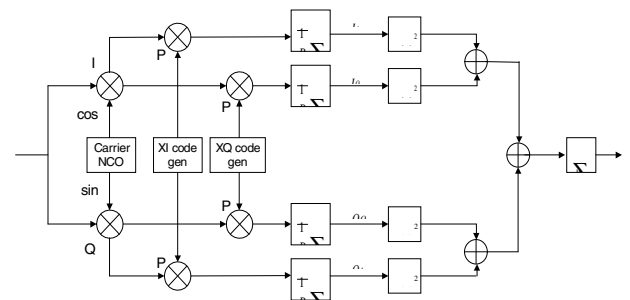

Figure 5: Proposed acquisition structure using both I and Q components

where

- $I_I(k)$ and $Q_I(k)$ are respectively the inphase and quadrature correlator outputs resulting from an integration over T_p s of the inphase component I of the searched signal
- $I_Q(k)$ and $Q_Q(k)$ are respectively the inphase and quadrature correlator outputs resulting from an integration over T_p s of the quadrature component Q of the searched signal
- M is the number of non coherent integrations
- T_p is the coherent integration time

Note:

In the following, cross-correlations between the I component code and the Q component code are neglected.

Only the approach assuming white thermal noise is presented in this section but extension to the presence of minor cross-correlation peaks is not a difficulty.

Therefore, assuming that the useful signal is corrupted by white noise, in the absence of the useful signal (H0), the criterion is

$$T_0 = \sum_{k=1}^M \left[n_{I_I}^2(k) + n_{Q_I}^2(k) + n_{I_Q}^2(k) + n_{Q_Q}^2(k) \right]$$

where

- n_{I_I} and n_{Q_I} are respectively the inphase and quadrature correlator outputs, dedicated to the inphase component of the searched signal
- n_{I_Q} and n_{Q_Q} are respectively the inphase and quadrature correlator output, dedicated to the quadrature component of the searched signal

All these 4 noise components are assumed to be independent and to have the following variance

$$\sigma_n^2 = \frac{N_0 f_p}{4}$$

$\frac{T_0}{\sigma_n^2}$ is a χ^2 distribution with $4M$ degrees of freedom so

given a false alarm probability $P_{fa} = \Pr[T_0 > Th]$, the threshold Th can easily be deduced. For instance, if the false alarm probability is equal to $P_{fa} = 10^{-3}$ then $Th = 99.6\sigma_n^2$ for $M=15$.

Thus, it may noted that even if the total noise power has doubled, the threshold has not been multiplied by two ($Th = 59.7\sigma_n^2$ for a single component).

In presence of the useful signal (H1), the criterion becomes

$$T_1 = \sum_{k=1}^M \left[\left(\sqrt{\frac{C}{4}} D(k) R_{I,f}(\epsilon_\tau) \frac{\sin(\pi\Delta f T_p)}{\pi\Delta f T_p} \cos(\epsilon_\theta) + n_{I_I}(k) \right)^2 + \left(\sqrt{\frac{C}{4}} D(k) R_{I,f}(\epsilon_\tau) \frac{\sin(\pi\Delta f T_p)}{\pi\Delta f T_p} \sin(\epsilon_\theta) + n_{Q_I}(k) \right)^2 + \left(\sqrt{\frac{C}{4}} R_{Q,f}(\epsilon_\tau) \frac{\sin(\pi\Delta f T_p)}{\pi\Delta f T_p} \cos(\epsilon_\theta) + n_{I_Q}(k) \right)^2 + \left(\sqrt{\frac{C}{4}} R_{Q,f}(\epsilon_\tau) \frac{\sin(\pi\Delta f T_p)}{\pi\Delta f T_p} \sin(\epsilon_\theta) + n_{Q_Q}(k) \right)^2 \right]$$

where

- $R_{I,f}$ is the normalized cross-correlation function of the inphase filtered incoming code and the inphase local
- $R_{Q,f}$ is the normalized cross-correlation function of the quadrature filtered incoming code and the quadrature local code

The test statistic $\frac{T_1}{\sigma_n^2}$ is now a noncentral χ^2 distribution

with $4M$ degrees of freedom, the noncentrality parameter is

$$\lambda = \frac{2M}{f_p} \frac{C}{N_0} R_f^2(\epsilon_\tau) \left(\frac{\sin(\pi\Delta f T_p)}{\pi\Delta f T_p} \right)^2$$

Note that this non centrality parameter is twice the value indicated in the single component use.

The probability of detection is then $\Pr[T_1 > Th] = Pd$ depending on the total (I+Q) C/N_0 at the antenna output through λ .

Next figure illustrates this probability for $P_{fa}=1e-3$, $T_p=1$ ms, $M=15, 40$ and 60 . Here no uncertainty (ϵ_τ and Δf) and no front end filtering effects are taken into account.

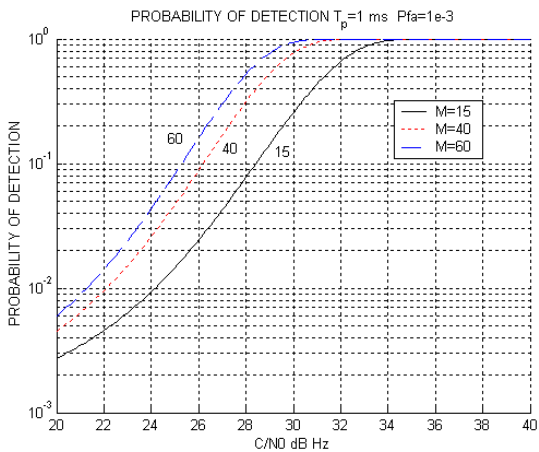

Figure 6: Probability of detection versus total (I+Q) C/N_0 at the antenna output using the I and Q components for 1 ms coherent integration time with the first approach and without front end filtering effects

Clearly, comparison of the previous figure with figure 2 shows that the probability of detection is higher, given C/N_0 , if both the components are used. Next table presents total (I+Q) required C/N_0 at the antenna output, using only one component I or Q and both components I and Q for studied signals. No degradation due to code and frequency uncertainty is considered.

Total (I+Q) required C/N_0 in dB Hz $P_{fa}=1e-3$ $T_p=1ms$ $M=15/40/60$	L5, E5a and E5b $f_c=10.23$ MHz Single component use I or Q	L5, E5a and E5b $f_c=10.23$ MHz Both components use I and Q
Pd=0.99	36.6/33.8/32.7	34.6/31.9/30.9
Pd=0.999	37.4/34.6/33.4	35.4/32.7/31.6

Table 1: Required total (I+Q) C/N_0 at the antenna output using only one component and both components with the first approach given probability of detection and probability of false alarm $1e-3$. Moreover no uncertainty and no front end filtering effects are considered

A gain of about 2 dB is achieved using both components. So it is advised to use the proposed acquisition structure given in Figure 5.

Note: if the E5b data rate is 500 sps (FEC 1/4), a gain of about 3 dB could be achieved in both approaches thanks to a longer predetection integration interval (2 ms) however the mean acquisition time would be higher.

Mean acquisition time computation

In case of the aided acquisition, 20460 code cells must be searched. Using expression given previously, next plot present the mean acquisition time results for $M=15$.

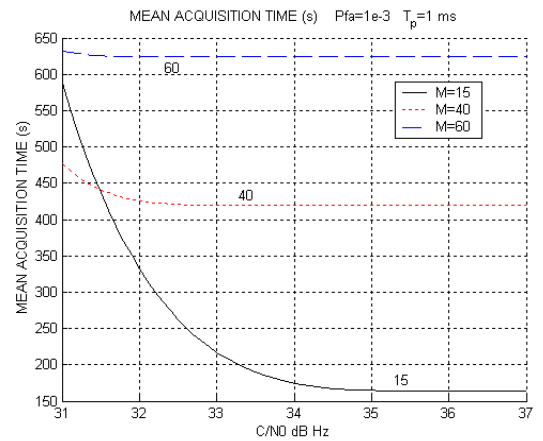

Figure 7: Single dwell search mean acquisition time versus total (I+Q) C/N_0 at antenna output using both the I and the Q components for $P_{fa}=1e-3$, 1 ms coherent integration time, searching for only one doppler bin and without front end filtering effects

Thus, assuming 15 non coherent integrations and 1 ms coherent integration time, the asymptotic mean acquisition time is again 163.68 s. This time is the same as the one computed in the case of the use of only one component. Thus this time appears to be a limit situation where the probability of detection is 1 and the false alarm probability is $1e-3$.

Moreover, processing simultaneously both I and Q channels now shows an improvement of about 2 dB on the required C/N_0 given the mean acquisition time. In particular using this structure, the reference 33.7 dBHz threshold now requires an acquisition time limited to about 180 s.

IV. TRACKING THRESHOLD COMPUTATION

The situation where the loop loses track is expressed, here, as the situation where there is a high probability that the loop discriminator function goes outside the limits of its linearity [Kaplan, 1996]. As, by definition, in the linear region, the discriminator function is linearly related to the tracking error, the distribution of the discriminator signal is directly linked to the distribution of the tracking error. The influence of noise on that distribution is given through the classical expressions of tracking error standard deviations due to noise given for PLLs and DLLs.

Only the Product Costas loop is studied in this part because expressions of tracking error standard deviations are not available for other discriminator such as the Arctangent or the Extended Arctangent. Concerning DLL, the Early-Minus-Late (EML) Power and the Dot Product discriminator are studied. Expressions of standard deviations are available in [Van Dierendonck, 1996].

Note that in general, computed thresholds are considered to be optimistic comparing with observed practical thresholds.

In this part, the inphase component and the pilot channel are studied separately however the indicated C/N_0 corresponds to the total (I+Q) required C/N_0 at antenna output. Code and carrier tracking using both components is not studied here.

Carrier tracking

Costas loops are used to track suppressed carrier signals. The prevalent sources of Costas tracking errors are phase jitter due to thermal noise. [Kaplan, 1996] proposed the tracking thresholds is computed so that the tracking error 3-sigma is below the limit of linearity of the phase discrimination function. The equation to verify is then

$$3\sigma_{PLL} < Th$$

where

- σ_{PLL} is the Costas tracking error standard deviation due to thermal noise
- Th is the threshold delimiting the linear region of the used discriminator

For the Product Costas loop, the tracking error standard deviation is [Van derendonck, 1996]

$$\sigma_{PLL} = \frac{360}{2\pi} \sqrt{\frac{B_n}{C} \left(1 + \frac{1}{2T_p \frac{C}{N_0}} \right)} \quad (\text{deg})$$

where

- B_n is the carrier loop noise bandwidth (Hz)
- $\frac{C}{N_0}$ is the signal power (in the tracking channel) to noise density ratio in dB Hz
- T_p is the predetection integration time (s)

The linear region of this discriminator is $-45 \text{ deg}/+ 45 \text{ deg}$ so $Th = 45^\circ$.

Figure 8 shows the total (I+Q) required C/N_0 at antenna output to track the phase of the signal versus loop noise bandwidths and for various predetection times.

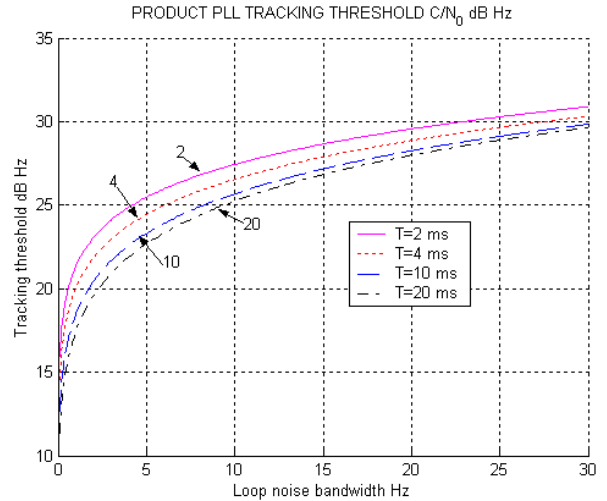

Figure 8: Required total (I+Q) C/N_0 at antenna output for Product PLL tracking versus loop noise bandwidths with various predetection times

If the dataless channel is used, after local multiplication by the local code and the NH code (L5 case), it remains only a carrier. Thus, it is possible to use a Phase Lock Loop (PLL) where the Integrate&Dump filter plays the role of the loop filter. The PLL has the following tracking error sigma [Holmes, 1990]

$$\sigma_{PLL}^2 = \frac{B_n}{C} \frac{1}{N_0}$$

Next figure presents phase tracking error standard deviations for the Product Costas loop ($B_n=10 \text{ Hz}$ $T=10 \text{ ms}$) and the PLL.

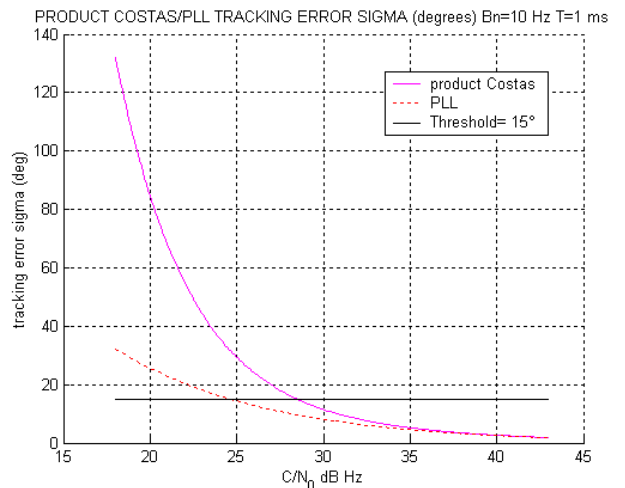

Figure 9: Comparison of Product Costas and PLL tracking error standard deviation versus total (I+Q) C/N_0 at antenna output for a 10 Hz loop noise bandwidth and a 1 kHz predetection bandwidth

Thus the total (I+Q) required C/N_0 at antenna output is 24.6 dB Hz for the PLL instead of 28.5 dB Hz for the Product Costas loop with a 1 ms coherent integration time.

Code tracking

Concerning DLL tracking thresholds, the rule-of-thumb tracking threshold is the same as the one used for the PLL [Kaplan, 1996]

$$3\sigma_{DLL} < Th$$

Tracking error sigma expressions due to thermal noise are available for several types of discriminators such as the Early-Minus-Late Power discriminator and the Dot Product discriminators that are studied here.

The Early-Minus-Late discrimination function is

$$(I_E^2 + Q_E^2) - (I_L^2 + Q_L^2)$$

where

- I_E and I_L are respectively the early and the late inphase correlator outputs
- Q_E and Q_L are respectively the early and the late quadrature correlator outputs

For this loop, the tracking error sigma due to thermal noise is [Van Dierendonck, 1996]

$$\sigma_{DLL} = \sqrt{\frac{B_n C_s}{2 \frac{C}{N_0}} \left(1 + \frac{2}{(2 - C_s) T_p \frac{C}{N_0}} \right)} \quad (\text{chip})$$

where

- B_n is the carrier loop noise bandwidth (Hz)
- C_s is the chip spacing between the late and the early code replica (chip)
- $\frac{C}{N_0}$ is the signal power (in the tracking channel) to noise density ratio in dB Hz
- T_p is the predetection integration time (s)

The linearity region limits of this discriminator are $\left[-\frac{C_s}{2}, \frac{C_s}{2} \right]$. Next Figure illustrates the effect of the predetection integration time on the total (I+Q) required C/N_0 at antenna output (tracking threshold) for a 0.5 chip spacing.

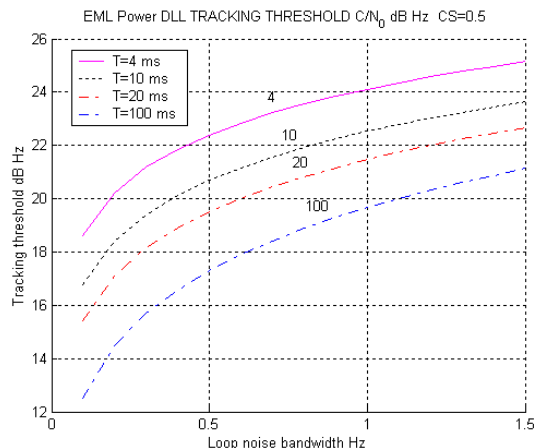

Figure 10: EML Power DLL total (I+Q) required C/N_0 at antenna output versus loop noise bandwidths with various predetection times and a 0.5 chip spacing

Dot Product discriminator results are indicated in [Bastide et al., 2002].

Assume the Dot Product DLL discriminator is used on the GPS L5 pilot channel; the predetection bandwidth can be reduced by summing more samples in the Integrate&Dump filter. If the closed loop bandwidth is 1 Hz, summation on 100 ms is a maximum to guarantee linear model validity. Previous figure shows then that the achievable gain is about 2 dB.

Conclusion

As a conclusion, next table summarizes total (I+Q) required C/N_0 at antenna output (tracking thresholds) for the studied code and phase tracking loops. Required threshold on the dataless channel is also presented.

Total (I+Q) required C/N_0 at antenna output in dB Hz	L5 50 bps	E5a 25 bps	E5b 125 bps	Pilot channel $T=100$ ms
Product Costas	25.7	25.2	26.5	24.6
Bn=10 Hz				
Dot Product DLL	22.5	21.1	23.5	19.5
Bn=1 Hz Cs=0.5				
EML Power DLL	22.1	21.5	24.1	19.7
Bn=1 Hz Cs=0.5				

Table 2: Total (I+Q) required C/N_0 (tracking thresholds) for L5, E5a, E5b signals and using a dataless channel

These tracking thresholds are quite low comparing with acquisition thresholds indicated in the previous part.

V. DEMODULATION THRESHOLD COMPUTATION

Correlator output, presented at the beginning of this paper, will be compared to a certain threshold to make a decision on the transmitted bit. It is possible to assume that tracking errors are negligible but in order to evaluate demodulation thresholds margin, it is preferable to assume no null errors. Code and phase tracking errors are both assumed to be centred Gaussian random variables with standard deviation dependent on loop noise bandwidth, C/N_0 , predetection time and chip spacing between early and late channels for the code tracking loop. All of these standard deviations are available in [Van Dierendonck, 1996]. A good way to take into account these errors and to put a margin is to consider that the expression $K_f(\epsilon_\tau)\cos(\epsilon_\theta)$ takes the value $K_f(\sigma_\tau)\cos(\sigma_\theta)$. As a validation [Hegarty, 1999] used the same technique for the degradation brought by the phase tracking error. Moreover, the effect of front end filtering is integrated in the power budget in the term “receiver processing loss” so these effects are not analysed here.

Galileo signals [Hein, 2001] and GPS L5 [RTCA, 2000] will use Forward Error Correction (FEC) codes in order to enhance demodulation performance. Currently, only characteristics of the code used on L5 are available. The L5, I channel, navigation data message is encoded with a FEC code which is a convolutional code of constrain length 7 and code rate 1/2. Generators in octal are: 133 and 171.

Decoding can be performed using a Viterbi algorithm applying hard or (quantized) soft decision. When the demodulator is used to take decisions on bits values, it quantizes its output to two levels and fed it to the decoder, this process is called hard decision decoding. For the soft decision decoding, demodulator output is quantized to Q levels, $Q > 2$. The decoding process is then based on algorithm manipulating Q -ary symbols. This process is more effective and the coding gain, defined as the difference between the required E_b/N_0 to achieve a given BER with respect to an uncoded transmission, is about 2.2 dB larger [Benedetto, 1987] comparing with the hard decision process.

A plot of the bit error rate performance of code using Viterbi soft and hard decision but also without any coding as a function of the bit energy to noise density ratio E_b/N_0 is given in Figure 11 [Proakis, 2001].

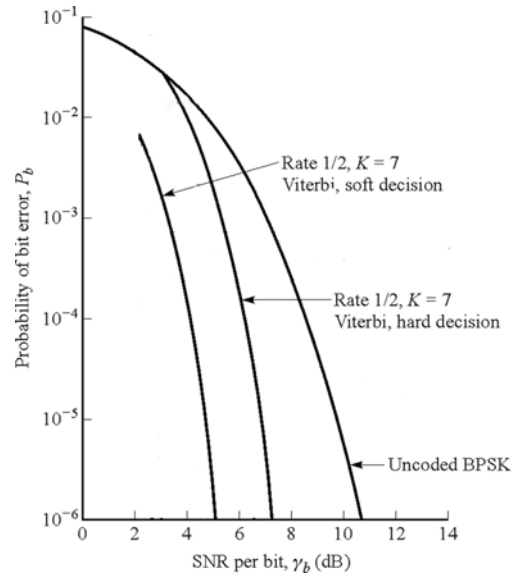

copyright McGraw-Hill

Figure 11: BER for L5 convolutional codes using soft and hard Viterbi decoding and BER for uncoded BPSK transmission

This plot is used to determine the required E_b/N_0 to achieve a certain BER then this ratio is converted in C/N_0

thank to the relation $\frac{C}{N_0} = \frac{E_b}{N_0} \frac{1}{T_p}$. Moreover,

degradations due to code and phase tracking errors may be taken into account using code and phase standard deviations indicated in the fourth part of this paper.

Note: for L5 signal with data rate 50 bps/100 sps and no post correlation power loss, we obtain a required $C/N_0 = 24.5$ dB Hz for $BER=10^{-5}$. This value is also indicated in [Hegarty, 1999].

As a conclusion, Table 3 summarizes results for a $BER=10^{-6}$ with and without degradations. The indicated results correspond to the total $(I+Q)$ required C/N_0 at the antenna output given BER. For L1 C/A, indicated results are related to the Inphase component of this signal.

Total (I+Q) required	L1 C/A 50 bps $T=20$ ms	L5 50 bps/100 sps $T=10$ ms	E5a 25 bps 50 sps $T=20$ ms	E5b 125 bps/250 sps $T=4$ ms
BER=10⁻⁶ without degradations	27.5	25.0	22.0	29.0
BER=10⁻⁶ with degradations	27.6	25.6	22.5	29.7

Table 3: L1 C/A, L5 and Galileo E5a/E5b total $(I+Q)$ required C/N_0 given BER with and without code and phase tracking errors degradations $K^2(\sigma_\tau)\cos^2(\sigma_\theta)$.

No front end filtering effects are considered

Note:

If a hard decision Viterbi algorithm is used, 2.2 dB must be added to these thresholds. Moreover, if Galileo E5b uses a FEC 1/4 code the demodulation threshold would be 32.7 dB Hz with degradation and so get closer to the acquisition threshold because of the higher symbol rate

VI. CONCLUSION

This study shows that the most stringent criteria to assess the impact of interference on GPS/L5, Galileo E5a and E5b signals is currently the acquisition threshold. The tracking thresholds may be reduced to low values due to the presence of a pilot channel (without data) for these three signals. The data demodulation threshold is also quite low for GPS/L5 and Galileo E5a due to low data rate, but is higher for Galileo E5b due to increased data rate and may reach the level of achievable acquisition thresholds (around 30 dB-Hz) as further discussed. It seems therefore important to limit the data rate of E5b signals, in particular to strict safety of life integrity service.

The conclusions concerning acquisition are as follows:

- Three types of acquisition thresholds have been investigated in this part: the cold start acquisition, the aided acquisition and the reacquisition after a short interruption.
- The time scales involved in the third case have been shown [Bastide et al, 2002] to be very limited, allowing to reduce greatly the acquisition thresholds, so that this case does not seem to be really dimensioning with respect to interference situation.
- The acquisition times obtained in first case are on the other hand very large, and very high acquisition thresholds may be required to manage this case, using classical receivers structures and a limited number of correlators.
- However for an aircraft in flight this case does not seem really significant since the most likely event is that the signal is lost during a limited period of time, so that only a limited acquisition corresponding to case 2 above has to be performed. This case is suggested to be the reference situation to further assess acquisition thresholds.
- For all above cases, there is an advantage of about 2dB in using a combination of I and Q signal power in the acquisition structure, which is thus recommended to be used for further assessment of relevant thresholds.
- In previous interference compatibility presented to ICAO and ITU studies a value of 33.7 dB Hz

threshold was retained to assess the level of acceptance of interference. This study has investigated a number of different hypotheses showing their potential impact on acquisition threshold. Considering that a wide range of thresholds values might be retained depending on the choice of test hypotheses, it seems difficult at this stage to confirm or infirm the validity of this preliminary value of 33.7 dB Hz for new GNSS signals offered to ICAO consideration for standardisation. However the following conclusions may be made:

- 1) The value of 33.7 dB Hz is in the range of threshold values which may be obtained using a limited number of correlators, classical acquisition techniques, classical receiver structures and reasonable assumptions on potential degradations,
- 2) An increase of the number of correlators, still using classical receiver structures, which seems to be easily achievable in the coming years at nearly no cost on receiver cost/complexity would allow to further reduce the acquisition thresholds in the range around 30 dB Hz

Finally it may be noted that the acquisition receiver structure considered here is simple and classical. More advanced acquisition structures could be considered using for example Fast Fourier Transforms. However their impact on user receiver on cost/complexity should be further assessed.

REFERENCES

- [Van Dierendonck, 1999], A.J Van Dierendonck « L5 Acquisition Considerations »
- [Van Dierendonck, 1996], A.J Van Dierendonck « GPS receivers » in “GPS: Theory and Applications”, AIAA
- [Holmes, 1990], J.K Holmes « Coherent Spread Spectrum Systems »
- [Bastide et al., 2002], F.Bastide, C.Macabiau and B.Roturier, « Note on Acquisition, Tracking and Demodulation Thresholds Computation », presented paper at RTCA Spectrum Subgroup meeting (April 8th – 12th , 2002)
- [Kaplan, 1996], E.D Kaplan “GPS Principles and applications”, Artech House Publishers
- [Hein, 2001], “The Galileo Frequency Structure and Signal Design”, Signal Task Force, 2001
- [RTCA, 2000], “NAVSTAR GPS L5 Signal Specifications”, RTCA, 2000
- [Benedetto,1987], “Digital Transmission Theory”, S.Benedetto, E.Biglieri, V.Castellani, 1987
- [Proakis, 2001], J.G Proakis “Digital Communication - fourth edition”, MacGRAW-HILL INTERNATIONAL EDITION, 2001

[Hegarty, 1999], C.Hegarty “Evaluation of the Proposed Signal Structure for the New Civil GPS signal at 1176.45 MHz”, June 1999, MITRE