



HAL
open science

Studies on acquisition and tracking threshold's reduction for GPS spaceborne and aeronautical receivers

René Landry, Laurent Lestarquit, Jean-Luc Issler, Abdelahad Benhallam

► To cite this version:

René Landry, Laurent Lestarquit, Jean-Luc Issler, Abdelahad Benhallam. Studies on acquisition and tracking threshold's reduction for GPS spaceborne and aeronautical receivers. ION GPS 98, 11th International Technical Meeting of the Satellite Division of The Institute of Navigation, Sep 1998, Nashville, United States. pp 619 - 625. hal-01021675

HAL Id: hal-01021675

<https://enac.hal.science/hal-01021675>

Submitted on 31 Oct 2014

HAL is a multi-disciplinary open access archive for the deposit and dissemination of scientific research documents, whether they are published or not. The documents may come from teaching and research institutions in France or abroad, or from public or private research centers.

L'archive ouverte pluridisciplinaire **HAL**, est destinée au dépôt et à la diffusion de documents scientifiques de niveau recherche, publiés ou non, émanant des établissements d'enseignement et de recherche français ou étrangers, des laboratoires publics ou privés.

STUDIES ON ACQUISITION AND TRACKING THRESHOLD'S REDUCTION FOR GPS SPACEBORNE AND AERONAUTICAL RECEIVERS

*René Jr. LANDRY - Laurent LESTARQUIT - Jean-Luc ISSLER - Abdelahad BENHALLAM***

CNES (THE FRENCH SPACE AGENCY), CNS / ENAC**
18 Av. Edouard Belin, 31401 Toulouse Cedex 4, France.
Tel : +33.(0)5.61.28.32.35 - Fax : +33.(0)5.61.28.26.13
E-mail: Rene.Landry@cnes.fr

KEY WORDS : Velocity Aiding, Autonomous Code Only, Threshold's Reduction, GPS Receiver Processing.

BIOGRAPHY

René Jr. Landry was born in Montreal, Quebec, Canada in 1968. After graduating (B.Sc.) from the Ecole Polytechnique of Montreal (Canada) in 92, he got the M.Sc. in Satellite Communication Engineering at the University of Surrey (UK) in 93. He received a Diplôme d'Etudes Approfondies (DEA) in Microwave Engineering with a Mastere in Space Electronics in 94, and his Ph.D. degree in Signal Processing in 97 at the Ecole Nationale Supérieure de l'Aéronautique et de l'Espace, ENSAE (Toulouse, France). His dissertation topic concerned anti-jamming technologies applied to the problem of civil aircraft interference using GPS receivers as a primary equipment of navigation. He has been involved in the design of a filter providing anti-jamming capability. He is presently a post doctoral research Staff in the RadioNavigation Department of the French Space Agency, CNES (Toulouse, France) . The present paper presents a status of his on going post doctoral studies.

Laurent Lestarquit is graduated from the Ecole Polytechnique of Paris in 94, and then specialised in space telecommunication systems at the Ecole Nationale de l'Aéronautique et de l'Espace, ENSAE in Toulouse, France. He joined the radionavigation department at CNES in 96, where he is currently working on spaceborne GPS receivers for project HETE2 (LEO) and CNES experimental telecommunication satellite STENTOR (GTO and GEO), and on the design of the future SCNS/INES navigation constellation (GNSS2).

Jean-Luc Issler is the head of the RadioNavigation Department at CNES. His main works concern spaceborne radionavigation receivers (DORIS, DORIS NG, GPS, GNSS1) and generators (GNSS1, GNSS2), and associated simulators. Ground GNSS receivers and generators involved in space systems are also his concern.

SUMMARY

This paper describes a method for threshold's reduction taking into account features both concerning GPS receiver modification and gain on the performances improvement. This method involves two steps. The goal is to use the strong channels of the GPS receiver which are actually tracking satellites for velocity aiding the other channel trying to acquire or track satellites presenting a low signal over noise ratio due to lower elevation or masking conditions. Second, according to the theory and the characteristics of the digital internal loops of the GPS receiver, the predetection bandwidth is reduced to the lowest value permitted by the velocity aiding accuracy. This technique allows to improve the GPS accuracy and robustness. The paper proposes and identifies the automatic model of a velocity aided loop. Furthermore, to allow the validation of the described threshold reduction method, the technique is proposed to be inserted and validated into a software simulator of a GPS receiver model. The on-going work is intended to be applied for space and aeronautical applications.

1. INTRODUCTION

The spaceborne GPS receivers are classically used in low earth orbit, with good GPS visibility conditions. However, some space missions require a GPS receiver operating with poor link budget. Such missions are for instance reentry capsule or shuttle (after radio black-out), high altitude spacecraft, GPS attitude determination, degraded pointing modes, radio-occultations and interference environment scenario. These applications need quick reacquisition of the GPS satellites, GPS receivers build-in robustness technology and better GPS visibility conditions than normal GPS navigation.

The aeronautical navigation GPS receivers need also acquisition and tracking threshold's reduction, for the following reasons :

- ✓ improvement of resistance to jammers, navigation availability and satellite's visibility.

- ✓ augmentation of accessible pseudorange measurements (improvement of RAIM).
- ✓ augmentation of accessible carrier phase measurements (improvement of phase tracking navigation).

The integrity is one of the major requirement for aeronautical mission. The objective is to maximise the number of tracked SV (Satellite Vehicle), even in the presence of interference. For a space mission where the C/N_o may be low, we are more concerned with the number of satellites that could be tracked. But, in orbit, the dynamic (acceleration) is always very small (for free orbital trajectories) and predictable. In these 2 domains of application, it is possible to reduce the threshold of GPS signal acquisition and tracking.

Also, in many situations, the acquisition process may be too long and/or the tracking loops of a GPS receiver may loose the lock of the signal during special conditions such as low satellite elevation angle or high dynamic manoeuvring. To improve the GPS acquisition time and the tracking performance an investigation is conducted on the use of additional internal GPS velocity aiding information.

The acquisition and tracking threshold reduction technique presented consists in supplying a pseudovelocity aiding to the carrier and/or the code loop, this pseudovelocity aiding is provided by the navigation filter itself (aeronautical PVT filter, or orbital Kalman filter, such as DIOGENE developed by CNES, where DIOGENE is « Determation Immédiate d'Orbite par GPS et Navigateur Embarqué », Immediate Orbit Determination with GPS and OnBoard Navigator). The technique enables to reduce the C/N_o thresholds below 20 dBHz, without any external aiding, other than a tight coupling between the on board navigator and the signal processing loops inside the GPS receiver.

OBJECTIVES AND METHODOLOGY

Many experiments are presently being carried out on the future DGPS-based approach and landing systems to improve the quality of aircraft navigation. The use of C/A-code receivers for aeronautical and spaceborne applications requires high reliability and integrity. Low visibility and satellite elevation angle during phases of flight can present problems for GPS reception of the channels presenting low C/N_o . The study of satellite missions and aeronautical environment show that GPS receiver must be provided with a strategy to reduce the acquisition and tracking thresholds to improve the navigation integrity, availability and performances, required for these missions.

This paper intends to present a status of the models studied to evaluate the Autonomous Velocity Aiding Performances .

The threshold reduction performance is evaluated versus the signal processing parameters of the receiver and the pseudovelocity aiding characteristics. Different models of this pseudovelocity aiding are presented, for the aeronautical and spaceborne applications. The main characteristics and theoretical performances of the aided processing loops are derived from these models.

1.1 External Velocity Aiding using INS

It is possible to reduce the threshold of the loop by reducing the predetection bandwidth [4]. This is possible if an external velocity aiding is provided (Figure 1-1). Such a process is detailed in many papers.

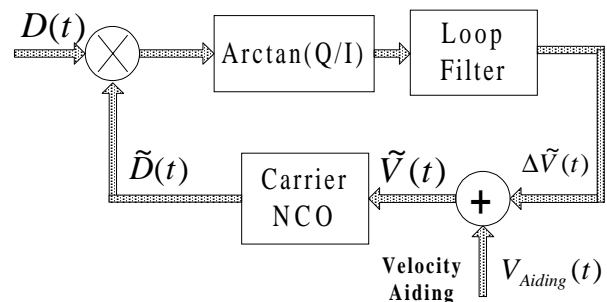

Figure 1-1: Loop with External Velocity Aiding.

This mode of operation is frequently used in military operation using integrated INS.

2. ANALYSIS OF LOOP PERFORMANCES

2.1 Noise Measurement

For the code loop with a programmable chip spacing, the standard deviation of the pseudorange noise measurement standard deviation (1σ) is approximated by :

$$\sigma_{PR}(m) = \frac{c}{R_c} \sqrt{\frac{B_{nm} \cdot C_s}{2 \left(\frac{C}{N_o}\right)} \cdot \left[1 + \frac{2B_{FI}}{\left(\frac{C}{N_o}\right)}\right]} \quad (2-1)$$

$c = 3 \times 10^8$ m/s ; speed of light,

$R_c = 1.023$ Mchip/sec ; C/A code speed,

$C_s = 1$ chip ; chip spacing (1/2, 1/4, 1/8, etc),

$B_{nm} = 1$ Hz ; code loop bandwidth,

$B_{FI} = 50$ Hz ; data predetection filter bandwidth,

C/N_o : signal to noise spectral density power ratio.

Numerical Application:

$B_{FI} = 50\text{Hz}$, $B_{nm} = 1\text{Hz}$ et $C/N_o = 40\text{dBHz}$
 we obtain, $\sigma_{PD} = 2\text{meters}$.

The standard deviation of the pseudovelocity error measured on the carrier is given by :

$$\sigma_{PV} (m/s) = \frac{c}{\sqrt{2\pi}f_i T_D} \sqrt{\frac{B_{np}}{\left(\frac{C}{N_o}\right)} \left[1 + \frac{B_{FI}}{2\left(\frac{C}{N_o}\right)}\right]} \quad (2-2)$$

f_i : transmitted frequency (F_{L1} , F_{L2} or others),
 $T_D = 1 \text{ sec}$; Doppler integration time,
 $B_{np} = 5 \text{ Hz}$; carrier loop filter bandwidth,

Numerical Application:

$B_{FI} = 50\text{Hz}$, $B_{np} = 10\text{Hz}$, $C/N_o = 40\text{dBHz}$ et $T_D = 0.6\text{s}$, we obtain $\sigma_{PV} = 0.35\text{cm/s}$.

One other possibility to measure the standard deviation of the code pseudospeed error is given by :

$$\sigma_{PV_{code}} = \frac{\sqrt{\sigma_{PR_k}^2 + \sigma_{PR_{k+1}}^2}}{t_{k+1} - t_k} = \frac{\sqrt{2} \cdot \sigma_{PR}}{\Delta t} \quad (2-3)$$

with $\sigma_{PR_k} = \sigma_{PR_{k+1}} = \sigma_{PR}$, $t_{k+1} - t_k = \Delta t$
 and t_i = date of pseudorange measurement, with instantaneous standard deviation σ_{PR_i} .

Numerical Application: $\sigma_{PV_{code}} = \frac{\sqrt{2} \cdot 2}{0.6} \cong 4\text{m/s}$

2.2 Code Loop Threshold on Tracking

The code loop condition to stay in lock is given by [4] :

$$a \cdot \sigma_{PR} \leq \frac{\Delta}{2} (m) \quad (2-4)$$

From equation (2-1), we obtain the following condition, with $C_s = 1$:

$$\frac{C}{N_o} \geq a^2 B_{nm} \cdot \left(1 + \sqrt{1 + \frac{4B_{FI}}{a^2 \cdot B_{nm}}}\right) \quad (2-5)$$

For $B_{FI} = 50\text{Hz}$, $B_{nm} = 1\text{Hz}$ and $a = 3$, we have :

$$\left[\frac{C}{N_o}\right]_{Boucle} \geq 17\text{dBHz} \quad (2-6)$$

For $B_{FI} = 250\text{Hz}$ instead of 50Hz , we have :

$$\left[\frac{C}{N_o}\right]_{Boucle} \geq 20\text{dBHz} \quad (2-7)$$

These values may be adjusted in function of the velocity aiding. Figure 2-1 shows the tracking threshold versus B_{FI} in function of B_{nm} .

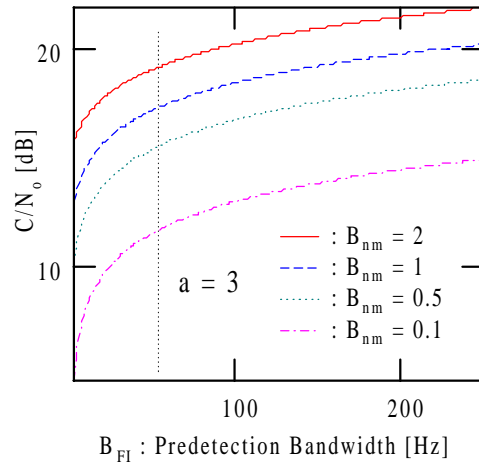

Figure 2-1: C/N_o versus B_{FI} (Variation of B_{nm}).

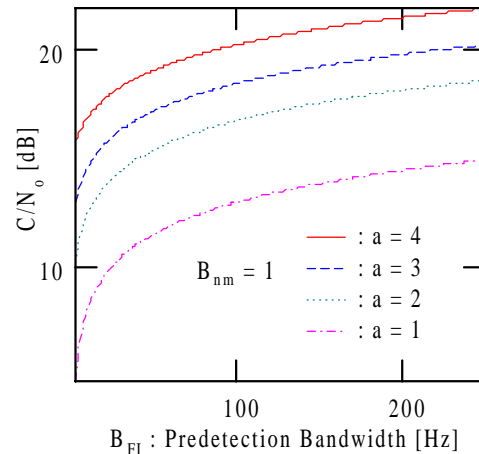

Figure 2-2: C/N_o versus B_{FI} (Variation of a).

3. MODEL OF AN AUTONOMOUS AIDED LOOP

A model of a tracking DLL aided by a velocity prediction coming from a local navigator is proposed hereafter:

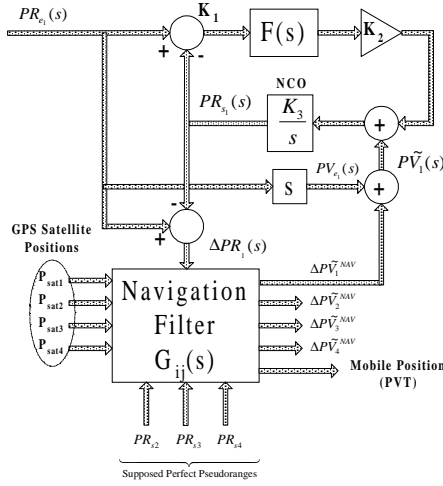

Figure 3-1: Modelling of the Loop with velocity aiding providing from GPS navigator (Autonomous Code ONLY).

3.1 Definitions, and Elaboration of a Model

A simplified model, using direct modelisation of the velocity aiding errors, is described hereafter.

The expression of the pseudorange measurement (PR) is generally written as :

$$PR_i^{Useful} = R_{r_i} + c \cdot \Delta T_i \quad (3-1)$$

where c is the speed of light, R the radial distance between the GPS satellite and the mobile and ΔT the time difference between the receiver and satellite clock.

After derivation, we obtain the expression of the real useful pseudovelocity (i.e. without error) :

$$PV_i^{Useful} = \frac{dPR_i^{Useful}}{dt} = \frac{dR_{r_i}}{dt} + c \cdot \frac{d\Delta T_i}{dt} = V_{r_i} + c \cdot \frac{d\Delta T_i}{dt} \quad (3-2)$$

where V_r is the radial speed of the receiver versus the transmitter, and $c \cdot d\left(\frac{\Delta T_i}{dt}\right)$ is the pseudovelocity due to the drifting shift of the clock between the receiver and the satellite i , noted also PV_i^{Clock} .

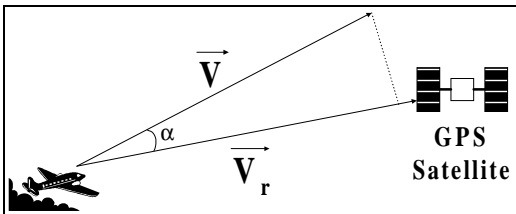

Figure 3-1: Mobile Radial Speed vs GPS Satellite.

$$PV_i^{Useful} = V_{r_i} + PV_i^{Clock} \quad (3-3)$$

The orbital navigator supplies an estimation $PV_i^{\tilde{V}}$ of the pseudovelocity corresponding to the aiding velocity noted :

$$PV_i^{Navigator} = PV_i^{\tilde{V}^{Useful}} = \tilde{V}_{r_i} + c \cdot d\left(\frac{\Delta \tilde{T}_i}{dt}\right) \quad (3-4)$$

where $c \cdot d\left(\frac{\Delta \tilde{T}_i}{dt}\right)$ is the estimated clock pseudovelocity of satellite i noted also $PV_i^{\tilde{V}^{Clock}}$.

Moreover, we introduce the raw measurement from the GPS receiver with the notation $PV_i^{Observable}$ corresponding to the pseudovelocity which can effectively be observed by the loops of the receiver, perturbed by the global error sources represented by the notation $\Delta PV_i^{Observable}$.

$$PV_i^{Observable} = V_{r_i} + PV_i^{Clock} + \Delta PV_i^{Observable} \quad (3-5)$$

where $V_{r_i} + PV_i^{Clock} = PV_i^{Useful}$ is the real useful pseudovelocity, from the navigator estimation.

The term $\Delta PV_i^{Observable}$ represent notably the perturbations due to SA (Selective Availability), to ionosphere, to multipaths and to jammers.

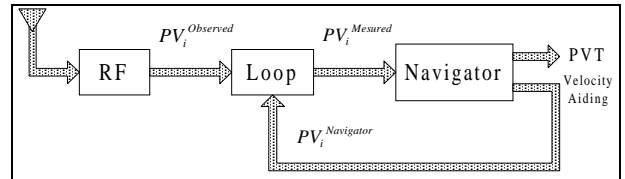

Figure 3-2: Relation between the PseudoVelocity Notations.

Reminding that the $PV_i^{Observable}$ is a characteristic of the received signal, it consists of physical pseudovelocity while $PV_i^{Measured}$ contains the steady state error of the loop such as the potential error reductions due to multipath coming from the loop and the thermal noise of the loop. N.B. The measurement $PV_i^{Measured}$ is of course available only when the loop is in tracking mode.

We have :

$$PV_i^{Navigator} = \tilde{V}_{r_i} + PV_i^{\tilde{V}^{Clock}} + \Delta PV_i^{Navigator} \quad (3-6)$$

where $\Delta PV_i^{Navigator}$ is the estimation error of the useful pseudospeed. The error on the aiding velocity supplied by the navigator and seen by the loops of the GPS receiver is notified by ΔPV_i^{Loop} . We obtain :

$$\Delta PV_i^{Loop} = PV_i^{Observable} - PV_i^{Navigator} \quad (3-7)$$

after some developments, we obtain :

$$\Delta PV_i^{Loop} = V_{r_i} + PV_i^{Clock} + \Delta PV_i^{Observable} - (V_{r_i} + PV_i^{Clock} + \Delta PV_i^{Navigator}) \quad (3-8)$$

after simplification :

$$\Delta PV_i^{Loop} = \Delta PV_i^{Observable} - \Delta PV_i^{Navigator} \quad (3-9)$$

The $\Delta PV_i^{Observable}$ represents the physical perturbation of the GPS signal notably due to the SA.

Examples of $\Delta PV_i^{Navigator}$ are presented bellow. It is known that the performance of orbit calculation of the Orbital Navigator such as DIOGENE are dependent on the type of orbit. Generally, we consider three types of orbit which are:

- Low Earth Orbit (LEO considered here at an altitude of 1000Km),
- Geostationary Orbit (GEO),
- Geostationary Transfer Orbit, after injection (GTO).

The performance of orbit calculation is estimated hereafter :

Type of Orbit	Clock Class	Precision
LEO	Short Term : $\Delta F/F=10^{-7}$	Position 100m (3σ), speed 0.1m/s (1σ).
GEO	$\Delta F/F=10^{-9}$,	Position 250m (3σ), speed 0.015m/s (1σ).
GTO	$\Delta F/F=10^{-9}$,	Position 500m (3σ), speed 0.08m/s (1σ).

Table 3-1 : Performance of Navigator vs Type of Orbit.

3.2 Analyse of the Loop Model

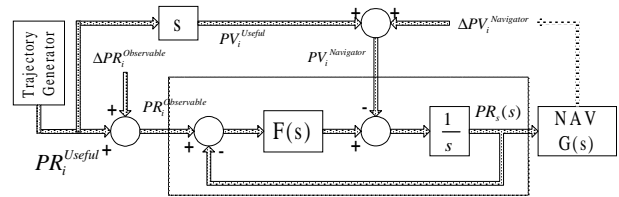

Figure 3-2: Mathematical Model of Autonomous Velocity Aiding Loop. We are searching to develop the following expression:

$$H_1(s) = \frac{PR_s(s)}{PR_i^{Useful}(s)} \quad (3-10)$$

$$(3-11)$$

$$PR_s(s) = \frac{[PR_e(s) - PR_s(s)] \cdot F(s) - PV_i^{Nav}(s)}{s} \quad (3-12)$$

$$(3-13)$$

$$PR_s(s) = \frac{PR_e(s) \cdot F(s)}{s} - \frac{F(s) \cdot PR_s(s)}{s} - \frac{PV_i^{Nav}(s)}{s} \quad (3-13)$$

$$\left[1 + \frac{F(s)}{s}\right] \cdot PR_s(s) = PR_e(s) \cdot \frac{F(s)}{s} - \frac{PV_i^{Nav}(s)}{s} \quad (3-13)$$

We have also:

$$PR_e(s) = \frac{[s \cdot PR_i^{Useful}(s) + \Delta PV_i^{Obs}(s)]}{s} \quad (3-14)$$

and:

$$PV_i^{Nav}(s) = s \cdot PR_i^{Useful}(s) + \Delta PV_i^{Nav}(s) \quad (3-15)$$

After some development, using (3-14) and (3-15), we obtain :

$$\left[1 + \frac{F(s)}{s} + \frac{G(s)}{s}\right] \cdot PR_s(s) = \quad (3-16)$$

$$\left[\frac{F(s)}{s} - 1\right] \cdot PR_i^{Useful}(s) + \frac{F(s) \cdot \Delta PR_i^{Obs}(s)}{s}$$

Where

$$G(s) = \frac{\Delta PV_i^{Navigator}(s)}{PR_s(s)} \quad (3-17)$$

is the transfer function of the Navigator for one channel.

The function can be analysed for several type of sinusoidal perturbations, noted :

$$p_i(t) = b_i \cdot \sin(\omega_i t) \quad (3-18)$$

Assuming the following perturbations :

$$\Delta PV_i^{Nav}(s) = \frac{b_1 \cdot \omega_1}{s^2 + \omega_1^2} = P_1(s) \quad (3-19)$$

This perturbation can represent the theoretical navigator harmonic error, for instance.

$$\Delta PV_i^{Obs}(s) = \frac{b_2 \cdot \omega_2}{s^2 + \omega_2^2} = P_2(s) \quad (3-20)$$

This perturbation can represent the selective availability, for instance.

Using $F(s) = \frac{K \cdot (s+a)}{s}$, and plugging in (3-16), we have:

$$\left[\frac{s^2 + Ks + a}{s^2} \right] \cdot PR_s(s) = PR_i^{Useful}(s) \cdot \left[\frac{-s^2 + Ks + a}{s^2} \right] + P(s) \quad (3-21)$$

where

$$P(s) = \frac{1}{s^2} \cdot \left[\frac{K \cdot (s+a)}{s} \cdot P_2(s) - s \cdot P_1(s) \right] \quad (3-22)$$

ie :

$$P(s) = \frac{1}{s^2} \cdot \left[\frac{K \cdot (s+a)}{s} \cdot \left(\frac{b_2 \cdot \omega_2}{s^2 + \omega_2^2} \right) - s \cdot \left(\frac{b_1 \cdot \omega_1}{s^2 + \omega_1^2} \right) \right] \quad (3-23)$$

Simulation of this model will be perform on a software GPS Receiver Simulator.

4. CODE ONLY PERFORMANCES IN ACQUISITION

The « Code Only Acquisition » threshold $[C/N_o]_{co}$ is approximated using the following formula [4] :

$$\left[\frac{C}{N_o} \right]_{co} > \frac{2a}{f(N_{cb}) \cdot \tau} \left(\sqrt{B_{FI} \cdot \tau \cdot f(N_{cb})} + a \right) \cdot L_{co} \cdot L_{ss} \quad (4-1)$$

- B_{FI} : Pre-Detection Bandwidth,
- B_{nm} : Noise Bandwidth (PR measures),
- L_{co} : Code Only threshold losses due to pseudovelocity error ($L_{co} > 1$),

- L_{ss} : Losses due to the sweeping speed α of the DLL local code,
- N_{cb} : Number of channels of the correlator,
- $F(N_{cb})$: Function of the number of correlator branch ;
 $F(N_{cb}) = N_{cb}$ or $f(N_{cb}) = \sqrt{N_{cb}}$.

ΔPV : PseudoVelocity error : ΔPV loop (cf 4-9),

with :

$$L_{co}(dB) = 10 * \log \left[\frac{\sin \left(\frac{\pi \cdot \Delta PV \cdot f_o}{B_{FI} \cdot c} \right)}{\left(\frac{\pi \cdot \Delta PV \cdot f_o}{B_{FI} \cdot c} \right)} \right]^2 \quad (4-2)$$

For $L_{co} < 3dB$:

$$abs[\Delta PV] < \frac{0.443 \cdot B_{FI} \cdot c}{f_o} \quad (4-3)$$

and

$$L_{ss} = 1 - \frac{\alpha}{2} + \frac{\alpha^2}{12} \quad (4-4)$$

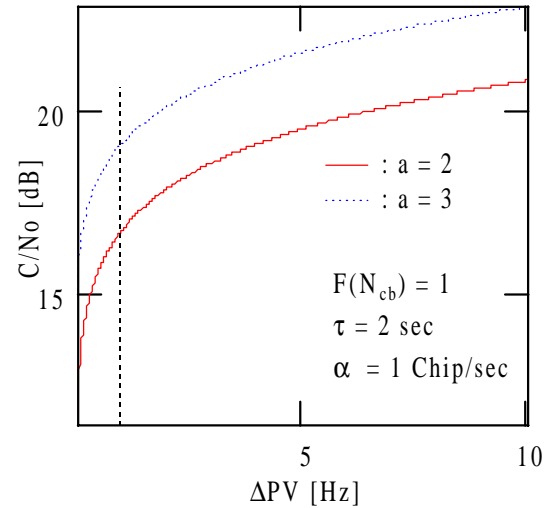

Figure 4-1: C/N_o vs Aiding Velocity Error .

5. GENERAL CONCLUSION

One of the main concerns with the use of GPS is the integrity and availability of the receiver navigation solution being used. The paper intends to bring some elements concerning a solution to improve the performance of the receiver for the channels presenting signals with low SNR. The status of a autonomous code only processing modeling has been presented. Simulation results will be presented in a future paper.

ACKNOWLEDGEMENTS

The authors would like to give special thanks to M.Jean-Louis Jonquière from Technical Service for Aircraft Navigation (STNA), for his interest in this on-going study. This study was made possible in part by a research grant from the STNA, and by a PostDoctoral grant from CNES, in association with ENAC.

REFERENCES

- [1] R.Jr.Landry, « *Modélisation d'un Récepteur GPS sur MATLAB : MATNAV VI.0* », Internal Post-Doc Report at CNES, Version 2.1, Toulouse, 5th September 1998.
- [2] R.Jr.Landry, « *Techniques d'Abaissement des Seuils d'Acquisition et de Poursuite pour les Récepteurs-* », Internal Post-Doc Report at CNES, Version 1.0, Toulouse, 1st June 1998.
- [3] R.W.Caroll and W.A.Mickelson, « *Velocity Aided of Non-Coherent GPS Receiver* », Proceedings of the IEEE 1977 National Aerospace and Electronics Conference, NAECON, 1977.
- [4] J.-L. Issler, J.Fourcade, L.Lestarquit, C.Mehlen, G.Garnier, « *High Reduction of Acquisition and Tracking Thresholds of GPS Spaceborne Receivers* », ION GPS 98, 19 January 1998.
- [5] Hugh Wightwick and Robert Wade, « *The Design, Implementation and Performance of a GPS Resident Close Coupled GPS-INS Integration Filter* », Proceedings of National Technical Meeting of Institute of Navigation, Anaheim, California, pp.673-681, USA, 1995.
- [6] He Xiufeng and Chen Yongqi, « *Analysis of the Performance of a GPS Receiver with Inertial Velocity Aided* », Navigation 2000, National Technical Meeting, Long Beach, California, January 21-23, 1998.